



Integrated Irrigation Management Solutions



BERMAD Irrigation

Product Guide

Effective: 2020

Water Control Solutions



Contacts

USA

BERMAD INC Irrigation Division

3816 S Willow Ave, #101
Fresno, CA 93725
phone: 559 791 1314
fax: 800 839 3884
info.us@bermad.com
www.bermad-inc.com

BRAZIL

BERMAD Brasil

Rua Anhaia, 1180 - 3º andar
Bom Retiro - CEP: 01130-000
São Paulo/SP
TEL: +55 11 3074 1199
FAX: +55 11 3074 1190
bermad.br@bermad.com
www.bermad.com.br

BERMAD Brasil IMP. E EXP

Rua Jesuino Arruda 797 Conj. 11 Itaim Bibi
Cep:04532-082, Sao Paulo - SP
TEL: +55 11 3074 1199
FAX: +55 11 3074 1190
bermad.br@bermad.com
www.bermad.com.br

MEXICO

BERMAD MEXICO AGRICULTURA S.A. DE C.V.

Carretera Mexico Toluca Km 53.5
Bldv Doña Rosa 2C
Zona Industrial Lerma
Lermad Edo. De Mexico
Tel: 728 1021600
Tel: 01 800 2237623
Email: info@bermad.com
www.bermad.com/mx

EUROPE

Spain

BERMAD Europe S.L.
Calle Comercio, 1 - Nave 22
08780 Pallejà, Barcelona
TEL: +34 932 225 125
FAX: +34 936 633 134
Bermad.eu@bermad.com
www.bermad.com

Italy

BERMAD Italy S.R.L.
Viale Ticino 84
Lonate Pozzolo (VA) 21015
TEL: +39 0331 301879
FAX: +39 0331 667693
www.bermad.com

France

BERMAD France S.A.S.
1 Louis Armand Square
Soisy Sous Montmorency 95230
TEL: +33 01 341 25352
FAX: +33 01 341 25336
info@bermad.com
www.bermad.com

UNITED KINGDOM

BERMAD UK Ltd

Unit 8 Hungerford Trading Estate
Smitham Bridge Road
Hungerford - Berkshire RG17 0QP
TEL: +44 1488 681713
FAX: +44 1488 684692
info@bermad.com
www.bermad.com

CHINA

BERMAD China Co. Ltd.

Plant B, Number 98, Lane 1971,
Lianhua South Road
Minhang District, Shanghai 201108
TEL: +86 21 544 09950
FAX: +86 21 544 09960
info.cn@bermad.com
www.bermad.com.cn

AUSTRALIA

BERMAD Water Technologies Pty

26 Brand Drive
Thomastown VIC 3074
TEL: +61 3 9464 23745
FAX: +61 3 9464 2382
bob@bermad.com.au
www.bermad.com.au

INDIA

506, Suratwala Mark Plazo,

411057, Hinjewadi, Pune
TEL: +91 9987076165
India@bermad.com
www.bermad.com

ISRAEL

BERMAD - HEADQUARTERS

Kibbutz Evron 22808
TEL: +972 4 985 5311
FAX: +972 4 985 7651
info@bermad.com
www.bermad.com

Table of Contents

100-DC Series - hYflow Double Chamber Composite Material Control Valves 1½" - 4"	6
100 Series - hYflow Composite Material Control Valves 1½" - 6"	12
200 Series - Composite Material Control Valves ½" - 2"	30
350 Series - Double Chamber Composite Material Filter Backwash Hydraulic Valves 2"X2" - 4"X4"	40
400 Series - Diaphragm Hydraulic Control Valves 1" - 16"	46
700 Series - High Performance Double Chambered Control Valves 1½" - 48"	62
900 Series - Hydrometer & Auto Metering Valves 1½" - 10"	80
WM Series - Turbo IR meters Paddle type 2" - 12"	96
WM Series - Turbo-Bar meters woltman type 1½" - 20"	100
WM Series - Bermad Euromag Electromagnetic Water Meters 1½" - 104"	104
AV Series - Kinetic, Automatic & Combination Air Valves ¾" - 12"	110
BIC Series - Bermad Irrigation Controllers	120
PRV Series - Composite Material Direct Acting Pressure Reducers ¾" - 1½"	136
S Series - Continuous (AC & DC) and Latching, 2-Way and 3-Way Solenoids	142
Mini Pilots - Composite Material and Metal 2-Way and 3-Way Pilots	149
Pilots and Floats - Metal 2-Way and 3-Way Pilots; Composite Material and Metal 2-Way and 3-Way Floats	150
Accessories - Full Range of Composite Materials and Metal Control Accessories	151
FT Series - Control Tube Fittings	152

New from BERMAD

Top Pilot Valves

BERMAD's new Top Pilot Valves are integrated Pressure Reducing or Pressure Sustaining valves equipped with pressure adjustment knob and scale for easy calibration. The "Box-Size" compact Top Pilot Valves require less accessories and fittings for providing excellent regulation performance and labor saving.

Top pilot is the only 3-way integrated pilot in the market and it is suitable for up to 3" valves.

IR-100-DC Double Chamber

BERMAD's IR-100-DC Series Polymeric Double Chamber Valves provide:

- Saving on power costs due to decreased pressure loss
- Powered non-slam closing characteristic
- Stable & accurate regulation at all operation conditions
- Isolated & protected diaphragm
- Special unique features: Proportional PRV, Fail Safe Closed, Powered Opening



Solenoid S-390T

BERMAD's new S-390T-2W, S-392T-2W and S-392T-3W compact Solenoid Actuators are especially designed for long and reliable service life in irrigation systems.

These Solenoid Actuators provide low sensitivity to dirt and voltage variations. Compatible with all electronic Irrigation Control Systems in the market, they can be directly installed on the Trio Valve Cover or Trio Base for integration.



Model IR-21T

BERMAD's 2-Way Solenoid Controlled Valve with the Trio integrated Open-Auto-Close manual selector, is hydraulically operated, diaphragm actuated control valve with internal hydraulic Feed & Bleed control loop.

The Trio Integrated selector allows for manual overriding of the electric signal; Open or Close.



BERMAD Euromag

BERMAD-EuroMag's MagMeters are robust state of the art flow meters for irrigation:

- They are well-suited for the whole range of irrigation water qualities
- They include integrated alarm for partially filled pipeline
- With No Moving Parts they provide Pipe-like flow path
- Their DC low power design is ideal for in-field battery operation
- They are highly accurate even at very low flow-rate



100 4L/6R

BERMAD's 105-4"L/6"R is the most cost-effective control valve for 120-180m³/h irrigation blocks. It provides:

- Very high flow with low head loss
- Accurate & stable regulation performances
- Variety of optional control features & end connections for serving as 4", 5" or 6" Irrigation Control Valves



Model IR-172-t

BERMAD's IR-172-t Flow Control & Pressure Reducing Valve limits system over-demand, controls laterals and distribution lines fill-up, while reducing the supply pressure.

Controlled by a Paddle-Type flow pilot, the IR-172-t valve provides wide on-site setting range without added head-loss.



IR-200 1/2"

BERMAD's 1/2" Plastic Valve is a diaphragm actuated Globe valve designed to serve as Control Accessory for Hydraulic Control Valves, Low Flow Irrigation systems and Fogging Systems.

The valve is available in two configurations:

- Solenoid controlled - model 21T
- Hydraulically controlled - model 205



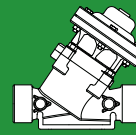

NEW



IR-100-DC Series

The BERMAD IR-100-DC Series Valves are double chambered hydraulically operated valves which provide: **Isolated and protected diaphragm, Stable and accurate regulation performances, Powered opening & closing, non-slam closing characteristic & decreased pressure loss (no spring).**

Double Chamber actuator assembly design consists of both upper and lower control chambers. Valves can easily be configured, on-site from single to double chamber control valve. The shaft sub assembly is center guided, providing an unobstructed seat area.

IR-100-DC Series are now upgrading the best irrigation valves in the world to also be double chamber, available in the range: Oblique (Y) - 1½", 2", 2"L, 2½", 3"; Angle - 2", 3"; "T" & Double (D) "T" patterns - 3"

Features and Benefits

- Line Pressure Driven
- Double Chambered Design
 - Requires low actuation pressure
 - Quick and powerful closure with soft non slam seal
 - Immediate response
 - Protected diaphragm
 - Near Zero Headloss
- User-Friendly Design
 - Simple structure and maintenance
- Pilotless proportional pressure reducing
- Accurate, stable and immediate modulation

Typical Applications

- Drip Systems
- Sprinklers & Micro-Sprinklers
- Greenhouses
- Flooding Tables Drainage (with External Pressure)
- Irrigation machine and distribution line Flush-'N-Stop
- Downhill irrigation and Distribution lines
- Low flow and low pressure operations
- Serial pressure reducing

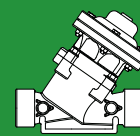

Principle of Operation (on/off)

3-Way Control

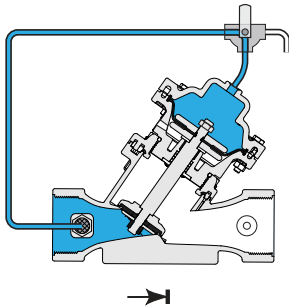

Closed Position

Line pressure applied to the control chamber of the valve creates a hydraulic force that moves the valve to the closed position and provides drip tight sealing.

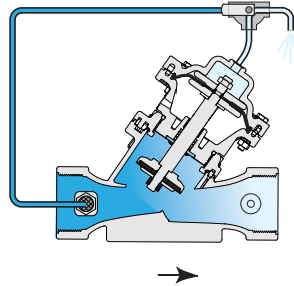

Open Position

Discharging the pressure from the control chamber to atmosphere or some other lower pressure zone, causes the line pressure acting on the seal disc to move the valve to the open position.

3-Way Control Normally Closed Valve with Hydraulic Power Opening

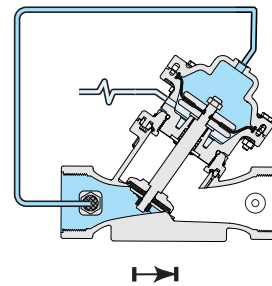

Closed Position

Line pressure is applied constantly to the Upper Control Chamber (UCC). When the Lower Control Chamber (LCC) is vented, it allows the line pressure in the UCC to push the diaphragm assembly, thereby discharging the water from the LCC, closing the valve. Pressurizing the LCC creates, together with the hydraulic force that acts on the plug, a superior force that overcomes the force in the UCC and opens the valve.

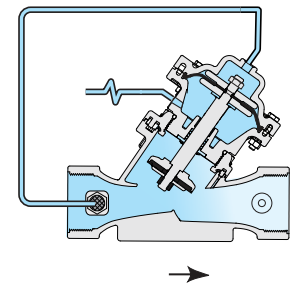

Open Position

Technical Specifications

Available Patterns & Sizes:

Oblique (Y) - 1½"-3"; DN40-DN80

Angle (A) - 2", 3"; DN50, DN80

"T" (T) & Double (D) patterns - 3"; DN80

Available End Connections:

Threaded:

Female BSP-T/NPT (1½"-3"; DN40-DN80)

Male BSP-F (2" & 2½"; DN50 & DN65)

Flanged: 3"

Universal Plastic or metal "Corona" ISO, ANSI, AS, JIS

PVC: 75mm, 90mm, 2.5", 3",

PVC "glue-in" adapters for cement welding

Victaulic: 2", 3", 4"

Plastic grooved adapters

Pressure Rating: 10bar; 150psi

Operating Pressure Range: 0.5-10bar; 7-150psi

Temperature Range: Water up to 60°C; 140°F

Standard Materials:

- **Body, Cover and Plug:** Polyamide (Nylon) 6 – 30GF Black
- **Diaphragm:** NR
- **Seals:** NR
- **Spring:** Stainless Steel
- **Cover bolts:** Stainless Steel

Flow Properties

Size	mm	40	50	50	50L	65	80	80	80	80	80	80
Pattern	Inch	1½"	2"	2"	2"L	2½"	3"	3"	3"	3"	3"	3"
		Y	Y	A	Y	Y	Y	A	T	TT	D	DD
KV		50	50	52	100	100	100	85	95	130	90	200
									One side	Two sides	One side	Two sides

$$\Delta P = \left(\frac{Q}{Kv} \right)^2$$

$Kv = m^3/h \text{ @ } \Delta P \text{ of 1 bar}$ $Cv = 1.155 Kv$
 $Q = m^3/h$
 $\Delta P = \text{bar}$

Flow Chart

2-Way circuit "Added Head Loss" (for "V" below 2 m/s): 0.3 bar

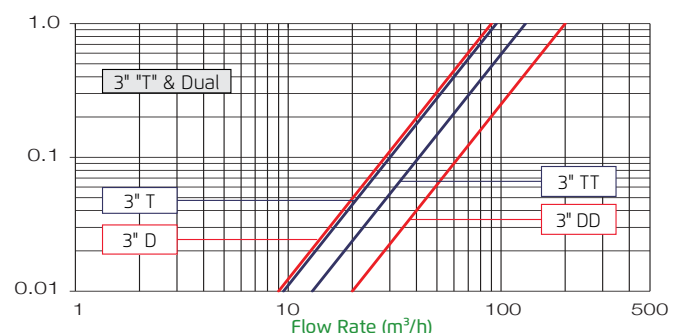
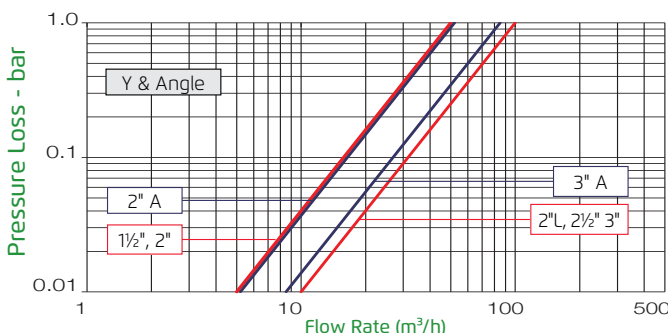

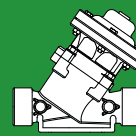

Dimensions & Weights

NEW								
	Size Inch; DN	1½"; 40	2"; 50	2"; 50	2"L; 50L	2½"; 50L	3"; 80	3"; 80
Pattern	Y DC	Y DC	Y DC	Y DC	Y DC	Y DC	Y DC	
End Connections	Rc 1½ (BSP.T)	G 2 (BSP.F)	Rc 2 (BSP.T)	Rc 2 (BSP.T)	G 2½ (BSP.F)	Rc 3 (BSP.T)	Universal Flanges	
	1½" NPT	---	2" NPT	2" NPT	---	3" NPT	Metal	Plastic
L (mm)	200	200	230	230	230	298	308	308
H (mm)	194	196	196	220	220	232	277	277
h (mm)	40	40	40	43	43	55	100	100
W (mm)	126	126	126	135	135	135	200	200
CCDV (lit)	0.13	0.13	0.13	0.17	0.17	0.17	0.17	0.17
Weight (Kg)	1.7	1.7	1.7	2.2	2.2	2.3	5.1	3.2

NEW						
	Size Inch; DN	2"; 50	3"; 80	3"; 80		3"; 80
Pattern	A DC	A DC	A DC		Dual DC	T DC
End Connections	Rc 2 (BSP.T)	Rc 3 (BSP.T)	Universal Flanges		Rc 3 (BSP.T)	Rc 3 (BSP.T)
	2" NPT	3" NPT	Metal	Plastic	3" NPT	3" NPT
L (mm)	115	133	138	138	200	133
H (mm)	266	286	291	291	302	287
h (mm)	126	118	123	123	116	119
W (mm)	115	135	200	200	135	135
CCDV (lit)	0.13	0.17	0.17	0.17	2x0.17	0.17
Weight (Kg)	1.7	2.3	5.1	3.2	4.6	2.8

CCDV = Control Chamber Displacement Volume

DC = Double Chamber

Other End Connections adapters are available on request.

For dimensions and weights of adapters or valve with adapters please consult with customer service

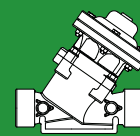

IR **3"** **120-DC** **55** **Y**

Size	End Connection	
1½"	DN40	Female Threaded
2"	DN50	Female Threaded, Male Threaded
2"L	DN50L	Female Threaded NEW
2½"	DN65	Male Threaded NEW
3"	DN80	Female Threaded, Flanged, Grooved, Horn NEW
3"L	DN80L	Flanged, Grooved or glue in NEW
4"	DN100	Flanged, Grooved or glue in NEW

Primary Features	Code
Basic Valve	100-DC
Solenoid Controlled Valve (Only 3 Way Control)	110-DC
Pressure Reducing Valve (Only 3 Way Control)	120-DC
Proportional Pressure Reducing Valve	120-PD
Pressure Reducing & Sustaining Valve (Only 3 Way Control)	123-DC
Pressure Sustaining Valve (Only 3 Way Control)	130-DC
Quick Pressure Relief Valve (Only 3 Way Control)	13Q-DC
Level Control Valve	150-DC
Level Control & Pressure Sustaining Valve (Only 3 Way Control)	153-DC

Other primary features available on request.

Additional Features	Code
No Additional Features	00
Check Feature	20
Solenoid Control & Check Feature	25
N.O. Hydraulic Remote Control	50
N.C. With Adjustable Hydraulic Relay	54X
N.C. with Hydraulic Relay	54
Solenoid Controlled	55
Modulating Horizontal Float	60
Green-App Control	4G
Bi-Level Electric Float	65
Normally Closed (Hydraulic)	NC
Proportional Pressure Reducing	PD

Reduction Ratios		
Valve Size	Reduction Ratio	
1½" & 2"	DN40 & DN50	3.3
2"L, 2½", 3", 3"L & 4"	DN50L, DN65, DN80, DN80L & DN100	2.7

Pattern	Available Sizes	Code
Oblique	All Sizes	Y
Angle	2" & 3"	A
Tee	3"	T
Dual Actuated Tee	3"	D

Construction Materials	Code
Nylon Glass Filled (Standard)	P

P **BP** **4AC** **PP** **M**

End Connections - Valve Body only (w/out adaptors)		Code
Threaded	BSP Female Threaded	BP
	NPT Female Threaded	NP
	BSP-F, Male Threaded (2" & 2½" ONLY)	BS
Horn	Inlet BSP x Outlet(s) Horn (3" Angle / Tee / Dual)	KB
	Inlet NPT x Outlet(s) Horn (3" Angle / Tee / Dual)	KN

End Connections - Valve Body with Adaptors***		Code
Flanged**	Plastic Flanges (3" & 4")	FF
	Plastic Flanges - NPT Threaded Body (3" & 4")	FN
	Metal Flanges - "Corona" (3" & 4")	CC
	Metal Flanges - NPT Threaded Body (3" & 4")	CN
PVC Cemented (glue-in)	PVC Inner Adaptors 75mmx3" BSP (3")	BJ
	PVC Inner Adaptors 2.5"X3" NPT (3")	NJ
	PVC Adaptors 90-110mm, BSP Threaded Body (3")	T1
	PVC Adaptors 110-125mm, BSP Threaded Body (3")	T2
	PVC Adaptors 3"-4", NPT Threaded Body (3", 3"L)	T3
	PVC Adaptors 4", NPT Threaded Body (3", 3"L)	T4
*Grooved Adaptors	BSP Threaded Body (2", 2"L & 3")	VB
	NPT Threaded Body (2", 2"L & 3")	VN

* Complies with: ANSI C 606-81
 ** Complies with: ISO PN10, BST-D, ANSI 125/150, JIS K-10
 *** For ordering the Adaptors separately see page 23
 Inlet x Outlet end connection combinations available on request.
 Please consult Customer Service for further information

Voltage-Main Valve Position (When Solenoid De-Energized)			Code
24VAC	-	Normally Closed	4AC
24VAC	-	Normally Open	4AO
24VDC	-	Normally Closed	4DC
24VDC	-	Normally Open	4DO
12VDC	-	Latch Solenoid S-985 (3 Leads)	1DS
12VDC	-	Latch Solenoid S-982 (2 Leads)	2DS
9VDC	-	Latch Solenoid	9DS

Tubing & Fittings	Code
Plastic Tubing & Fittings	PP

Additional Attributes Unlimited Selection		Code
3-Way Control Loop		X
Auxiliary Closing Spring		K
Differential Pressure Duct (2"L-4")		D
External Control Pressure		e
Lifting Opening Spring		L
Flow Stem		M
Flow Over-the-Seat		O
Manual Selector		Z
Low Preset Pressure (below 2 bar)		2
Plastic Pressure Test Point		5
½" Anti Vacuum at Valve Downstream		7

Other additional attributes are optional.
 Please consult Customer Service for further information.



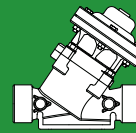

Hydraulic Control Basic Valve - Double Chamber

IR-100-DC

Size	Pattern	Connection
1½"	DN40	Y Threaded
2"	DN50	Y Threaded
		A Threaded
2"L	DN50L	Y Threaded
2½"	DN65	Y Threaded
3"	DN80	A FF

Size	Pattern	Connection
3"	DN80	A Threaded
		D Threaded
		T Threaded
		Y FF Threaded



Hydraulic Control Basic Valve - Double Chamber

with Manual Selector

IR-100-DC-Z

Size	Pattern	Connection
1½"	DN40	Y Threaded
2"	DN50	Y Threaded
		A Threaded
2"L	DN50L	Y Threaded
2½"	DN65	Y Threaded
3"	DN80	Y Threaded

Size	Pattern	Connection
3"	DN80	Y FF
		A Threaded
		FF
		T Threaded
D Threaded		



Solenoid Controlled Valve - Double Chamber

with 3-Way Control

IR-110-DC-X

Solenoid S-390-3W; S-400

Size	Pattern	Connection
1½"	DN40	Y Threaded
2"	DN50	Y Threaded
		A Threaded
2"L	DN50L	Y Threaded
2½"	DN65	Y Threaded
3"	DN80	Y Threaded

Size	Pattern	Connection
3"	DN80	Y FF
		A Threaded
		FF
		T Threaded
D Threaded		



(*) Standard 24V AC. For other voltage see Ordering Guide
Variable End Connections (adaptors) available - see End Connection table

Pressure Reducing Differential Valve - Double Chamber

IR-120-DC-PD

Size	Pattern	Connection
1½"	DN40	Y Threaded
2"	DN50	Y Threaded
		A Threaded
2"L	DN50L	Y Threaded
2½"	DN65	Y Threaded
3"	DN80	Y Threaded

Size	Pattern	Connection
3"	DN80	Y FF
		A Threaded
		FF
		T Threaded
D Threaded		



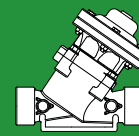

Pressure Reducing Valve - Double Chamber

with 3-Way Control, Manual Selector

IR-120-DC-XZ

Size	Pattern	Connection
1½"	DN40	Y Threaded
2"	DN50	Y Threaded
		A Threaded
2"L	DN50L	Y Threaded
2½"	DN65	Y Threaded
3"	DN80	Y Threaded

Size	Pattern	Connection
3"	DN80	Y FF
		A Threaded
		FF
		T Threaded
	D	Threaded

Variable End Connections (adaptors) available - see End Connection table



Pressure Reducing Valve - Double Chamber

with Solenoid Control 3-Way, Manual Selector

IR-120-DC-55-XZ

Solenoid S-390-3W; S-400

Size	Pattern	Connection
1½"	DN40	Y Threaded
2"	DN50	Y Threaded
		A Threaded
2"L	DN50L	Y Threaded
2½"	DN65	Y Threaded
3"	DN80	Y Threaded

Size	Pattern	Connection
3"	DN80	Y FF
		A Threaded
		FF
		T Threaded
	D	Threaded

(*) Standard 24V AC. For other voltage see Ordering Guide
Variable End Connections (adaptors) available - see End Connection table



Quick Pressure Relief Valve - Double Chamber

IR-130Q-DC

Size	Pattern	Connection
1½"	DN40	Y Threaded
2"	DN50	Y Threaded
		A Threaded
2"L	DN50L	Y Threaded
2½"	DN65	Y Threaded

Size	Pattern	Connection
3"	DN80	Y Threaded
		FF
	A	Threaded
		FF

Variable End Connections (adaptors) available - see End Connection table





IR-100 Series hYflow

The BERMAD IR-100 hYflow is at the leading edge of control valve design, providing a valve that is free of the typical limitations associated with standard control valves.

A unitized flexible super-travel diaphragm & guided plug provide a significantly 'look through' passage resulting in accurate & stable regulation and ultra-high flow capacity.

The hYflow unique body design allows on-site adaption to a wide range of end connection types and sizes. Its articulated flange connections isolate the valve from pipeline bending & pressure stresses.

*Valves up to 3" can be converted to double chamber on-site

Available in sizes:

Oblique (Y) - 1½", 2", 2"L, 2½", 3", 3"L, 4", 4"L, 6"R & 6" ;

Angle - 2", 3", 3"L, 4"

"T" & Double (D) "T" patterns - 3"



Features and Benefits

- Hydraulic Control Valve
 - Line pressure driven
 - Hydraulically controlled On/Off
- Engineered Composite Material Valve with Industrial Grade Design
 - Adaptable on-site to a wide range of end connection sizes and types
 - Articulated flange connections eliminate mechanical and hydraulic stresses
 - Highly durable, chemical and cavitation resistant
- hYflow 'Y' Valve Body with "Look Through" Design
 - Ultra-high flow capacity - Low pressure loss
- Unitized Flexible Super Travel Diaphragm and Guided Plug
 - Smooth closing
 - Requires low actuation pressure
 - Prevents diaphragm erosion and distortion
- User-Friendly Design
 - Simple in-line inspection and service

Typical Applications

- Irrigation Control Head
- In-Field Control Head
- LPS - Low Pressure Systems
- Energy Saving Irrigation Systems
- Computerized Irrigation Systems

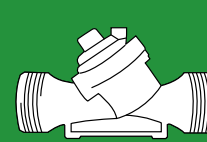

Operation Modes (On/Off)

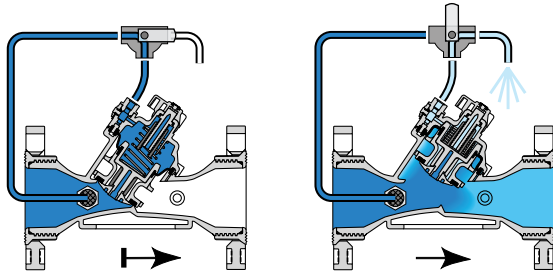

3-Way Control

Line pressure applied to the control chamber of the valve creates a hydraulic force that moves the valve to the closed position and provides drip tight sealing. Discharging pressure from the control chamber to the atmosphere causes the line pressure under the plug to open the valve.

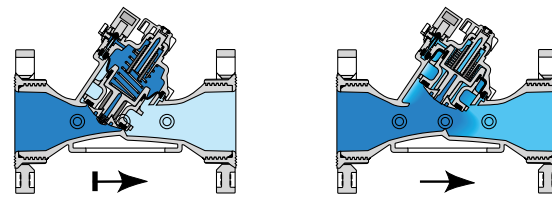

2-Way Internal Control

Line pressure enters the control chamber through the internal restriction. The closed solenoid causes pressure to accumulate in the control chamber, thereby shutting the valve. Opening the Solenoid releases more flow from the control chamber than the restriction can allow in. This causes pressure in the control chamber to drop, allowing the valve to open.

Technical Specifications

Available Patterns & Sizes:

Oblique (Y) - 1½"-6"; DN40-DN150
 Angle (A) - 2", 3", 3"L, 4"; DN50, DN80, DN80L, DN100
 "T" (T) & Double (D) patterns - 3"; DN80

Available End Connections:

Threaded:

Female BSP-T/NPT (1½"-3"L; DN40-DN80L)

Male BSP-F (2" & 2½"; DN50 & DN65)

Flanged:

3", 3"L, 4", 4"L, 6"R & 6"

Universal Plastic or metal "Corona" ISO, ANSI, AS, JIS

PVC: 75mm, 90mm, 110mm, 2.5", 3", 4"

PVC "glue-in" adapters for cement welding

Victaulic:

2", 3", 4"
 Plastic grooved adapters

Pressure Rating:

10bar; 150psi

Operating Pressure Range: 0.5-10bar; 7-150psi

Temperature Range: Water up to 60°C; 140°F

Standard Materials:

- **Body, Cover and Plug:** Polyamide (Nylon) 6 – 30GF Black
- **Diaphragm:** NR
- **Seals:** NR
- **Spring:** Stainless Steel
- **Cover bolts:** Stainless Steel

Flow Properties

Size	DN Inch	40 1½	50 2	50 2	50L 2L	65 2½	80 3	80 3	80 3	80 3	80 3	80 3	80L 3L	80L 3L	100 4	100 4"	100L 4L	150R 6R	150 6
Pattern		Y	Y	A	Y	Y	Y	A	T	TT	D	DD	Y	A	Y	A	Y	Y	Y
									One side	Two sides	One side	Two sides							
KV		50	50	50	100	100	100	85	95	130	90	200	200	190	200	190	340	340	400

$$\Delta P = \left(\frac{Q}{Kv} \right)^2$$

$Kv = m^3/h @ \Delta P \text{ of } 1 \text{ bar}$ $Cv = 1.155 Kv$
 $Q = m^3/h$
 $\Delta P = \text{bar}$

Flow Chart

2-Way circuit "Added Head Loss" (for "V" below 2 m/s): 0.3 bar

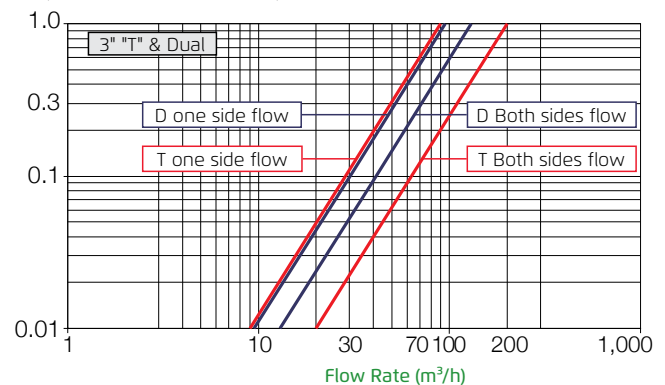
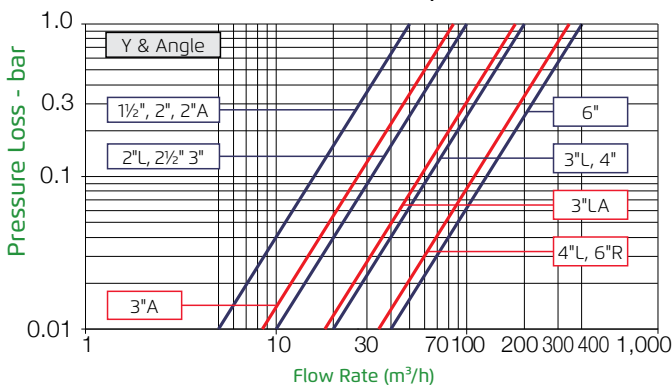



Dimensions & Weights

Size Inch; DN	1½"; 40	2"; 50	2"; 50	2"L; 50L	2½"; 50L	3"; 80	3"; 80	
Pattern	Y	Y	Y	Y	Y	Y	Y	
End Connections	Rc 1½ (BSP.T)	Rc 2 (BSP.T)	G 2 (BSP.F)	Rc 2 (BSP.T)	G 2½ (BSP.F)	Rc 3 (BSP.T)	Universal Flanges	
	1½" NPT	2" NPT	---	2" NPT	---	3" NPT	Metal	Plastic
L (mm)	200	230	230	230	230	298	308	308
H (mm)	173	173	173	187	187	199	244	244
h (mm)	40	40	40	43	43	55	100	100
W (mm)	97	97	97	135	135	135	200	200
CCDV (lit)	0.12	0.12	0.12	0.15	0.15	0.15	0.15	0.15
Weight (Kg)	1.1	1.2	1.2	1.47	1.47	1.6	4.4	2.5

Size Inch; DN	3"L; 80L	3"L; 80L	4"; 100	4"L; 100L	6"; 150					
Pattern	Y	Y	Y	Y	Y "Boxer"					
End Connections	Rc 3 (BSP.T)	Universal Flanges		Universal Flanges			Grooved Ends	Universal Flanges		
	3" NPT	Metal	Plastic	Metal	Plastic	Metal			Plastic	
L (mm)	298	308	308	350	350	442	442	470	480	504
H (mm)	278	317	317	329	329	340	340	377	198	286
h (mm)	60	100	100	112	112	112	112	149	100	143
W (mm)	168	200	200	224	224	226	226	287	475	475
CCDV (lit)	0.62	0.62	0.62	0.62	0.62	1.15	1.15	1.15	2x0.62	2x0.62
Weight (Kg)	3	4.4	3.5	7.5	4.6	13.5	10	16.5	11	12.5

Size Inch; DN	2"; 50	3"; 80		3"L; 80L			4"; 100		3"; 80		3"; 80
Pattern	A	A		A			A		Dual		T
End Connections	Rc 2 (BSP.T)	Rc 3 (BSP.T)	Universal Flanges		Rc 3 (BSP.T)	Universal Flanges		Universal Flanges		Rc 3 (BSP.T)	Rc 3 (BSP.T)
	2" NPT	3" NPT	Metal	Plastic	3" NPT	Metal	Plastic	Metal	Plastic	3" NPT	3" NPT
L (mm)	115	133	138	138	150	155	155	176	176	200	133
H (mm)	216	246	251	251	343	348	348	369	369	269	247
h (mm)	115	118	123	123	140	145	145	166	166	116	119
W (mm)	97	135	200	200	170	200	200	224	224	135	135
CCDV (lit)	0.12	0.15	0.15	0.15	0.62	0.62	0.62	0.62	0.62	2x0.15	0.15
Weight (Kg)	0.8	1.6	4.4	2.5	2.8	5.6	3.7	7.2	4.4	3.2	2.1

CCDV = Control Chamber Displacement Volume DC = Double Chamber Other End Connections adapters are available on request.
 For dimensions and weights of adapters or valve with adapters please consult with customer service





IR **3"** **120** **55** **Y** **P** **BP** **4AC** **PP** **XZ**

Size	End Connection
1 1/2" DN40	Female Threaded
2" DN50	Female Threaded, Male Threaded
2"L DN50L	Female Threaded
2 1/2" DN65	Male Threaded
3" DN80	Female Threaded, Flanged, Grooved, Horn
3"L DN80L	Female Threaded, Flanged, Grooved or Glue in
4" DN100	Flanged Grooved or Glue in
4"L DN100	Flanged, Grooved NEW
6"R DN150	Flanged or Glue in NEW
6" DN150	Flanged or Grooved

Primary Features	Code
Basic Valve	105
Solenoid Controlled Valve	110
Solenoid Controlled TRIO Valve (2"L-3")	NEW 11T
Pressure Reducing Valve	120
Pressure Reducing TOP PILOT Valve (1 1/2"-3")	NEW 12T
Pressure Reducing & Sustaining Valve	123
Pressure Sustaining Valve	130
Differential Pressure Sustaining Valve	136
Quick Pressure Relief Valve	13Q
Level Control Valve	150
Level Control & Pressure Sustaining Valve	153
Flow Control Valve	170
Flow Control & Pressure Reducing Valve	172
Strainer (3"L, 4")	10F

Other primary features available on request.

Additional Features	Code
No Additional Features	00
Closing and opening speed control	03
Accelerated Closing	04
Electric Valve, without Solenoid	05
Check feature	20
Solenoid Control & Check Feature	25
N.O. Hydraulic Remote Control	50
N.C. With Adjustable Hydraulic Relay	54X
N.C. with Hydraulic Relay	54
Solenoid Controlled	55
Modulating Horizontal Float	60
Bi-Level Electric Float	65
Green-App Control	4G
Internal Feed & Bleed*	N
TOP PILOT with 12-40 PSI adjusting scale & Spring (2-Way Only)	J1
TOP PILOT with 12-80 PSI adjusting scale & Spring	J2
TOP PILOT with 0.8-3.0 Bar adjusting scale & Spring (2-Way Only)	H1
TOP PILOT with 0.8-6.0 Bar adjusting scale & Spring	H2

* Internal Feed & Bleed options N1-N7 available according to specific Application Engineering definitions.

Pattern	Available Size	Code
Oblique	(all sizes)	Y
Angle	2", 3" & 3"L/4"	A
Tee	3"	T
Dual Actuated Tee	3"	D

Construction Materials	Code
Nylon Glass Filled (Standard)	P
Polypropylene (Special Applications - 3"L, 4" only)	PP

End Connections - Valve Body only (w/out Adaptors)		Code
Threaded	BSP-T Female Threaded	BP
	NPT Female Threaded	NP
	BSP-F, Male Threaded (2" & 2 1/2" ONLY)	BS
Grooved*	Victaulic (4"L, 6")	VI
Horn	Inlet BSP x Outlet(s) Horn (3" Angle / Tee / Dual)	KB
	Inlet NPT x Outlet(s) Horn (3" Angle / Tee / Dual)	KN

End Connections - Valve Body with Adaptors***		Code	
Flanged**	Plastic Flanges (3", 3"L, 4", 4"L, 6")	FF	
	Plastic Flanges - NPT Threaded Body (3", 3"L, 4")	FN	
	Metal Flanges - "Corona" (3", 3"L, 4", 4"L, 6"R)	CC	
	Metal Flanges - NPT Threaded Body (3", 3"L, 4")	CN	
PVC Cemented (glue-in)	PVC Inner Adaptors 75mmx3" BSP (3", 3"L)	BJ	
	PVC Inner Adaptors 2.5"X3" NPT (3", 3"L)	NJ	
	PVC Adaptors 90-110mm, BSP Threaded Body (3", 3"L)	T1	
	PVC Adaptors 110-125mm, BSP Threaded Body (3", 3"L)	T2	
	PVC Adaptors 3"-4", NPT Threaded Body (3", 3"L)	T3	
	PVC Adaptors 4", NPT Threaded Body (3", 3"L)	T4	
	PVC Adaptors 160mm (6"R)	T6	
	*Grooved Adaptors	BSP Threaded Body (2", 2"L, 3", 3"L, 4")	VB
		NPT Threaded Body (2", 2"L, 3", 3"L, 4")	VN

* Complies with: ANSI C 606-81

** Complies with: ISO PN10, BST-D, ANSI 125/150, JIS K-10

*** For ordering the Adaptors separately see page 23
Inlet x Outlet end connection combinations available on request.
Please consult Customer Service for further information

Voltage-Main Valve Position (When Solenoid De-Energized)		Code
24VAC - Normally Closed		4AC
24VAC - Normally Open		4AO
24VDC - Normally Closed		4DC
24VDC - Normally Open		4DO
12VDC - Latch Solenoid S-985 (3 Leads)		1DS
12VDC - Latch Solenoid S-982 (2 Leads)		2DS
9VDC - Latch Solenoid		9DS

Other electrical ratings available on request.

Tubing & Fittings	Code
Plastic Tubing & Fittings (standard)	PP

Additional Attributes Unlimited Selection	Code
Servo (2/3-Way Control Loop)	b
3-Way Control Loop	X
Differential Pressure Duct (2"L-4")	D
External Control Pressure	e
Flow Stem	M
Manual Selector	Z
Low Preset Pressure (below 2 bar)	2
Plastic Pressure Test Point	5
1/2" Anti Vacuum at Valve Downstream	7

Other additional attributes are optional. Please consult our customer service for further information.





Hydraulic Control Basic Valve

IR-105

Size	Pattern	Connection
1½"	DN40	Y Threaded
2"	DN50	Y Threaded
		A Threaded
2"L	DN50L	Y Threaded
2½"	DN65	Y Threaded
3"	DN80	Y Threaded
		Y FF
		A Threaded
		A FF
		T Threaded
	D	Threaded

Size	Pattern	Connection
3"L	DN80L	Y Threaded
		A FF
4"	DN100	Y Threaded
		A FF
4"L	DN100L	Y FF
		Y CC
		Grooved
6"R	DN150R	Y FF
		Y CC
6"	DN150	Y FF / VI



Variable End Connections (adaptors) available - see End Connection table

Hydraulic Control Valve

with Manual Selector

IR-105-Z

Size	Pattern	Connection
1½"	DN40	Y Threaded
2"	DN50	Y Threaded
		A Threaded
2"L	DN50L	Y Threaded
2½"	DN65	Y Threaded
3"	DN80	Y Threaded
		Y FF
		A Threaded
		A FF
		T Threaded
	D	Threaded

Size	Pattern	Connection
3"L	DN80L	Y Threaded
		A FF
4"	DN100	Y Threaded
		A FF
4"L	DN100L	Y FF
		Y CC
		Grooved
6"R	DN150R	Y FF
		Y CC
6"	DN150	Y FF / VI



Variable End Connections (adaptors) available - see End Connection table

Trio Solenoid Controlled Valve

with 2-Way Internal Control

IR-11T-N-2W

Solenoid S-390-T-2W

Size	Pattern	Connection
2"L	DN50L	Y Threaded
2½"	DN65	Y Threaded
3"	DN80	Y Threaded
		Y FF

Size	Pattern	Connection
3"	DN80	A Threaded
		T FF
		T Threaded
	D	Threaded

New



(* Standard 24V AC. For other voltage see Ordering Guide
Variable End Connections (adaptors) available - see End Connection table



Trio Latching Solenoid Controlled Valve

with 2-Way Internal Control

IR-11T-LS-N-2W

Solenoid S-392-T-2W, 6-20V/DC Latch

Size	Pattern	Connection	Size	Pattern	Connection		
2"L	DN50L	Y	3"	DN80	Threaded		
2½"	DN65	Y			A	Threaded	
3"	DN80	Y			T	FF	
						D	Threaded
							Threaded

Variable End Connections (adaptors) available - see End Connection table



GreenApp Controlled Valve

Application Operated

IR-11T-GreenApp

Size	Pattern	Connection	Size	Pattern	Connection		
2"L	DN50L	Y	3"	DN80	Threaded		
2½"	DN65	Y			A	Threaded	
3"	DN80	Y			T	FF	
						D	Threaded
							Threaded

Variable End Connections (adaptors) available - see End Connection table



Hydraulic Control Valve, Normally Closed

with 3-Way Hydraulic Relay

IR-105-54-X

Size	Pattern	Connection	Size	Pattern	Connection	
1½"	DN40	Y	3"L	DN80L	Threaded	
2"	DN50	Y			FF	
		A			Threaded	
2"L	DN50L	Y	4"	DN100	Y	FF
2½"	DN65	Y			A	FF
3"	DN80	Y	4"L	DN100L	Y	FF
						A
		T				
						D
		CC				
		6"R				DN150R
6"	DN150	Y	FF / VI			

Variable End Connections (adaptors) available - see End Connection table





Solenoid Controlled Valve

with 3-Way Control

IR-110-X

Solenoid S-390-3W; S-400

Size	Pattern	Connection	Size	Pattern	Connection			
1½"	DN40	Y Threaded	3"L	Y	Threaded			
2"	DN50	Y Threaded		A	FF			
		A Threaded	Threaded					
2"L	DN50L	Y Threaded	4"	Y	FF			
2½"	DN65	Y Threaded		A	FF			
3"	DN80	Y	4"L		Y	FF		
		FF		CC				
		A		Threaded		Grooved		
		FF		6"R		DN150R	Y	FF
		T						Threaded
D	Threaded	6"	DN150	Y	FF / VI			



(*) Standard 24V AC. For other voltage see Ordering Guide
Variable End Connections (adaptors) available - see End Connection table

GreenApp Controlled 3W Valve

Application Operated

IR-110-GreenApp-X

Size	Pattern	Connection	Size	Pattern	Connection			
1½"	DN40	Y Threaded	3"L	Y	Threaded			
2"	DN50	Y Threaded		A	FF			
		A Threaded	Threaded					
2"L	DN50L	Y Threaded	4"	Y	FF			
2½"	DN65	Y Threaded		A	FF			
3"	DN80	Y	4"L		Y	FF		
		FF		CC				
		A		Threaded		Grooved		
		FF		6"R		DN150R	Y	FF
		T						Threaded
D	Threaded	6"	DN150	Y	FF / VI			



Variable End Connections (adaptors) available - see End Connection table

Latching Solenoid Controlled Valve

with 3-Way Control

IR-110-LS-X

Solenoid: S-982-3W / S-985-3W Latching, 12-50V/DC

Size	Pattern	Connection	Size	Pattern	Connection			
1½"	DN40	Y Threaded	3"L	Y	Threaded			
2"	DN50	Y Threaded		A	FF			
		A Threaded	Threaded					
2"L	DN50L	Y Threaded	4"	Y	FF			
2½"	DN65	Y Threaded		A	FF			
3"	DN80	Y	4"L		Y	FF		
		FF		CC				
		A		Threaded		Grooved		
		FF		6"R		DN150R	Y	FF
		T						Threaded
D	Threaded	6"	DN150	Y	FF / VI			



Variable End Connections (adaptors) available - see End Connection table



Top Pilot Pressure Reducing Valve

with 3-Way Control

IR-12T-X

Size	Pattern	Connection
1½"	DN40	Y Threaded
2"	DN50	Y Threaded
		A Threaded
2"L	DN50L	Y Threaded
2½"	DN65	Y Threaded
3"	DN80	Y Threaded

Size	Pattern	Connection
3"	DN80	Y FF
		A Threaded
		FF
		T Threaded
	D	Threaded

New



Variable End Connections (adaptors) available - see End Connection table

Pressure Reducing Valve

with 3-Way Control, Manual Selector

IR-120-XZ

Size	Pattern	Connection
1½"	DN40	Y Threaded
2"	DN50	Y Threaded
		A Threaded
2"L	DN50L	Y Threaded
2½"	DN65	Y Threaded
3"	DN80	Y Threaded
		FF
	A	Threaded
	FF	
	T	Threaded
	D	Threaded

Size	Pattern	Connection
3"L	DN80L	Y Threaded
		FF
	A	Threaded
4"	DN100	Y FF
		A FF
4"L	DN100L	Y FF
		CC
		Grooved
6"R	DN150R	Y FF
		CC
6"	DN150	Y FF / VI



Variable End Connections (adaptors) available - see End Connection table

Pressure Reducing Valve

with 3-Way Control, Hydraulic Control and Manual Selector

IR-120-50-XZ

Size	Pattern	Connection
1½"	DN40	Y Threaded
2"	DN50	Y Threaded
		A Threaded
2"L	DN50L	Y Threaded
2½"	DN65	Y Threaded
3"	DN80	Y Threaded
		FF
	A	Threaded
	FF	
	T	Threaded
	D	Threaded

Size	Pattern	Connection
3"L	DN80L	Y Threaded
		FF
	A	Threaded
4"	DN100	Y FF
		A FF
4"L	DN100L	Y FF
		CC
		Grooved
6"R	DN150R	Y FF
		CC
6"	DN150	Y FF / VI



Variable End Connections (adaptors) available - see End Connection table



Pressure Reducing Valve

with 2/3-Way (Servo) Control, Hydraulic Control and Manual Selector

IR-120-50-bZ

Size	Pattern	Connection
1½"	DN40	Y Threaded
2"	DN50	Y Threaded
		A Threaded
2"L	DN50L	Y Threaded
2½"	DN65	Y Threaded
3"	DN80	Y Threaded
		Y FF
		A Threaded
		A FF
		T Threaded
D Threaded		

Size	Pattern	Connection
3"L	DN80L	Y Threaded
		A FF
4"	DN100	Y Threaded
		A FF
4"L	DN100L	Y FF
		Y CC
6"R	DN150R	Y FF
6"	DN150	Y CC
6"	DN150	Y FF / VI



Variable End Connections (adaptors) available - see End Connection table

Pressure Reducing Valve

with 3-Way Control, 3-Way Hydraulic Relay, Normally Closed

IR-120-54-X

Size	Pattern	Connection
1½"	DN40	Y Threaded
2"	DN50	Y Threaded
		A Threaded
2"L	DN50L	Y Threaded
2½"	DN65	Y Threaded
3"	DN80	Y Threaded
		Y FF
		A Threaded
		A FF
		T Threaded
D Threaded		

Size	Pattern	Connection
3"L	DN80L	Y Threaded
		A FF
4"	DN100	Y Threaded
		A FF
4"L	DN100L	Y FF
		Y CC
6"R	DN150R	Y FF
6"	DN150	Y CC
6"	DN150	Y FF / VI



Variable End Connections (adaptors) available - see End Connection table

Pressure Reducing Valve

with 2/3-Way (Servo) Control, 3-Way Hydraulic Relay, Normally Closed

IR-120-54-b

Size	Pattern	Connection
1½"	DN40	Y Threaded
2"	DN50	Y Threaded
		A Threaded
2"L	DN50L	Y Threaded
2½"	DN65	Y Threaded
3"	DN80	Y Threaded
		Y FF
		A Threaded
		A FF
		T Threaded
D Threaded		

Size	Pattern	Connection
3"L	DN80L	Y Threaded
		A FF
4"	DN100	Y Threaded
		A FF
4"L	DN100L	Y FF
		Y CC
6"R	DN150R	Y FF
6"	DN150	Y CC
6"	DN150	Y FF / VI



Variable End Connections (adaptors) available - see End Connection table



Pressure Reducing Valve

with 2-Way Solenoid Control

IR-120-55-2W

Solenoid S-390-T-2W

Size	Pattern	Connection	Size	Pattern	Connection	
1½"	DN40	Y Threaded	3"L	Y	Threaded	
2"	DN50	Y Threaded		A	A	FF
		A Threaded	Threaded			
2"L	DN50L	Y Threaded	4"	Y	FF	
2½"	DN65	Y Threaded		A	A	FF
3"	DN80	Y	4"L			Y
				FF	CC	
		A		Threaded	Grooved	
		FF				
		T		Threaded		
D	Threaded					
6"R	DN150R	Y	6"	Y	FF / VI	
6"	DN150	Y				



(*) Standard 24V AC. For other voltage see Ordering Guide
Variable End Connections (adaptors) available - see End Connection table

Top Pilot Pressure Reducing Valve

with Solenoid Control 3-Way

IR-12T-55-X

Solenoid S-39T-3W

Size	Pattern	Connection	Size	Pattern	Connection	
1½"	DN40	Y Threaded	3"	Y	FF	
2"	DN50	Y Threaded		A	A	Threaded
		A Threaded				FF
2"L	DN50L	Y Threaded		T	Threaded	
2½"	DN65	Y Threaded	D	Threaded		
3"	DN80	Y Threaded				

New



(*) Standard 24V AC. For other voltage see Ordering Guide
Variable End Connections (adaptors) available - see End Connection table

Pressure Reducing Valve

with Solenoid Control 3-Way

IR-120-55-X

Solenoid S-390-3W; S-400

Size	Pattern	Connection	Size	Pattern	Connection	
1½"	DN40	Y Threaded	3"L	Y	Threaded	
2"	DN50	Y Threaded		A	A	FF
		A Threaded	Threaded			
2"L	DN50L	Y Threaded	4"	Y	FF	
2½"	DN65	Y Threaded		A	A	FF
3"	DN80	Y	4"L			Y
				FF	CC	
		A		Threaded	Grooved	
		FF				
		T		Threaded		
D	Threaded					
6"R	DN150R	Y	6"	Y	FF / VI	
6"	DN150	Y				



(*) Standard 24V AC. For other voltage see Ordering Guide
Variable End Connections (adaptors) available - see End Connection table



Pressure Reducing Valve

with 2/3-Way (Servo) Control, 3-Way Solenoid Control

IR-120-55-b

Solenoid S-390-3W; S-400

Size	Pattern	Connection	Size	Pattern	Connection
1½"	DN40	Y Threaded	3"L	DN80L	Y Threaded
2"	DN50	Y Threaded		4"	DN100
	2"L	DN50L	A Threaded		
2½"		DN65	Y Threaded	6"R	DN150R
	3"	DN80	Y Threaded		6"
FF			A	FF	
Y Threaded		Y			CC
FF				Grooved	



Variable End Connections (adaptors) available - see End Connection table

Pressure Reducing & Sustaining Valve

with 3-Way Control, Manual Selector

IR-123-XZ

Size	Pattern	Connection	Size	Pattern	Connection
1½"	DN40	Y Threaded	3"L	DN80L	Y Threaded
2"	DN50	Y Threaded		4"	DN100
	2"L	DN50L	A Threaded		
2½"		DN65	Y Threaded	6"R	DN150R
	3"	DN80	Y Threaded		6"
FF			A	FF	
Y Threaded		Y			CC
FF				Grooved	



Variable End Connections (adaptors) available - see End Connection table

Pressure Sustaining Valve

with 3-Way Control, Manual Selector

IR-130-XZ

Size	Pattern	Connection	Size	Pattern	Connection
1½"	DN40	Y Threaded	3"L	DN80L	Y Threaded
2"	DN50	Y Threaded		4"	DN100
	2"L	DN50L	A Threaded		
2½"		DN65	Y Threaded	6"R	DN150R
	3"	DN80	Y Threaded		6"
FF			A	FF	
Y Threaded		Y			CC
FF				Grooved	



Variable End Connections (adaptors) available - see End Connection table



Pressure Sustaining Valve

with 3-Way Solenoid Control

IR-130-55-X

Solenoid S-390-3W; S-400

Size	Pattern	Connection	Size	Pattern	Connection
1½"	DN40	Y Threaded	3"L	DN80L	Y Threaded FF
2"	DN50	Y Threaded		4"	DN100
		A Threaded	4"L		
2"L	DN50L	Y Threaded		6"R	DN150R
2½"	DN65	Y Threaded	6"		
3"	DN80	Y Threaded FF			
		A Threaded FF			
		T Threaded			
		D Threaded			



(*) Standard 24V AC. For other voltage see Ordering Guide
Variable End Connections (adaptors) available - see End Connection table

Quick Pressure Relief Valve

IR-13Q

Size	Pattern	Connection	Size	Pattern	Connection
1½"	DN40	Y Threaded	3"L	DN80L	Y FF A Threaded
2"	DN50	Y Threaded		4"	DN100
		A Threaded	4"L		
2"L	DN50L	Y Threaded		6"R	DN150R
2½"	DN65	Y Threaded	6"		
3"	DN80	Y Threaded FF			
		A Threaded FF			
3"L	DN80L	Y Threaded			



Variable End Connections (adaptors) available - see End Connection table

Level Control Valve

with Modulating Horizontal Float

IR-150-N-60

Size	Pattern	Connection	Size	Pattern	Connection
1½"	DN40	Y Threaded	3"L	DN80L	Y FF A Threaded
2"	DN50	Y Threaded		4"	DN100
		A Threaded	4"L		
2"L	DN50L	Y Threaded		6"R	DN150R
2½"	DN65	Y Threaded	6"		
3"	DN80	Y Threaded FF			
		A Threaded FF			
3"L	DN80L	Y Threaded			



Variable End Connections (adaptors) available - see End Connection table
(*) Optional IR-150-6L for low pressure applications, Available on request.



Flow Control Valve

with Diferential Pressure Duct and Manual Selector

IR-170-bDZ

Size	Pattern	Connection
1½"	DN40	Y Threaded
2"	DN50	Y Threaded
		A Threaded
2"L	DN50L	Y Threaded
2½"	DN65	Y Threaded
3"	DN80	Y Threaded
		Y FF
		A Threaded
		A FF
		T Threaded
D Threaded		

Size	Pattern	Connection
3"L	DN80L	Y Threaded
		A FF
4"	DN100	Y Threaded
		A FF
4"L	DN100L	Y FF
		Y CC
6"R	DN150R	Y Grooved
6"	DN150	Y FF
		Y CC
6"	DN150	Y FF / VI



Variable End Connections (adaptors) available - see End Connection table

Pressure Reducing & Sustaining Valve

with 3-Way Control, Hydraulic Control and Manual Selector

IR-123-50-XZ

Size	Pattern	Connection
1½"	DN40	Y Threaded
2"	DN50	Y Threaded
		A Threaded
2"L	DN50L	Y Threaded
2½"	DN65	Y Threaded
3"	DN80	Y Threaded
		Y FF
		A Threaded
		A FF
		T Threaded
D Threaded		

Size	Pattern	Connection
3"L	DN80L	Y Threaded
		A FF
4"	DN100	Y Threaded
		A FF
4"L	DN100L	Y FF
		Y CC
6"R	DN150R	Y Grooved
6"	DN150	Y FF
		Y CC
6"	DN150	Y FF / VI



Variable End Connections (adaptors) available - see End Connection table

Flow Control Valve & Pressure Reducing Valve

with Diferential Pressure Duct and Manual Selector

IR-172-bDZ

Size	Pattern	Connection
1½"	DN40	Y Threaded
2"	DN50	Y Threaded
		A Threaded
2"L	DN50L	Y Threaded
2½"	DN65	Y Threaded
3"	DN80	Y Threaded
		Y FF
		A Threaded
		A FF
		T Threaded
D Threaded		

Size	Pattern	Connection
3"L	DN80L	Y Threaded
		A FF
4"	DN100	Y Threaded
		A FF
4"L	DN100L	Y FF
		Y CC
6"R	DN150R	Y Grooved
6"	DN150	Y FF
		Y CC
6"	DN150	Y FF / VI



Variable End Connections (adaptors) available - see End Connection table



Strainer (Stone & Gravel Trap)

IR-10F

Size		Pattern	Connection
3"L	DN80L	Y	Threaded
			FF
			CC

Size		Pattern	Connection
4"	DN100	Y	FF
			CC



Variable End Connections (adaptors) available - see End Connection table

Additional Features & Options - Suffix Code

Code	Description
50-3W-P	Hydraulic Control (T Selector Shuttle Valve) - Plastic
50-2W-P	Hydraulic Control (2-Way Hydraulic Relay) - Plastic
54-3W-P	3-Way Hydraulic Relay (3W-HRV) ½" - Plastic
55	Solenoid Controlled
Z	Manual Selector
M	Flow Stem (For 1½" - 3")
M	Flow Stem (For 3"L - 4")
M	Flow Stem (For 6")
K/L	Auxiliary Closing / Lifting Spring
5*	Plastic Test Point

* Plastic Test Point is Standard for all regulating valves.

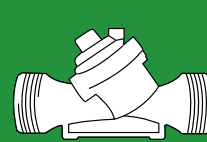

Add on Price for End Connections Adaptors - Kits / Packs

	Code	Description	Description / Item	Kits per Pack
	VN	2" Grooved x NPT Male Adaptor	2" Grooved x NPT (2 Kits) Cat.# 2620PL4G25-Pack	12
	3"-FF	3"-3"L Plastic Flange Assy	3"-3"L Plastic Flange Assy. - Pack Cat.# 113L060091-Pack	6
	4"-FF	4" Plastic Flange Assy	4" Plastic Flange Assy.- Pack Cat.# 1140060091-Pack	6
	4"L-FF	4"L Plastic Flange Assy	N.A.	
	3"-CC	3"-3"L Ductile Iron, "Corona" Flange Assy. 3"	3"-3"L Ductile Iron, "Corona" Flange Assy. 3" - Pack Cat.# 113L0P0091-Pack	6
	4"-CC	4"-4"R, Ductile Iron, "Corona" Flange Assy. 4"	4"-4"R, Ductile Iron, "Corona" Flange Assy. 4" - Pack Cat.# 11400P0091-Pack	6
	4"L-CC	4"-4"L, Ductile Iron, "Corona" Flange Assy. 4"	N.A.	
	6"R-CC	6"-6"R, Ductile Iron, "Corona" Flange Assy. 6"	N.A.	
	BJ	3"-3"L, PVC Inner 75mm x 3" BSP-T Male	3"-3"L, PVC Inner Adaptors 75mm x 3" BSP-T Male Cat.# 11300PV075-Pack	12
	T1	3"-3"L, PVC Glue-in Adaptors 90mm ID / 110mm OD	3"-3"L, PVC Glue-in Adaptors - Pack 90mm ID / 110mm OD Cat.# 1130SPV110-Pack	6
	T2	3"-3"L, PVC Glue-in Adaptors 110mm ID / 125mm OD	3"-3"L, PVC Glue-in Adaptors - Pack 90mm ID / 110mm OD Cat.# 11300PV125-Pack	6
	T6	6" PVC Glue-in Adaptors 160mm ID	N.A.	
	VB	2" Grooved x BSPT Male Adaptor	2" Grooved x BSPT- Pack Cat.# 2620PL3G25-Pack	12
	V3	3"-3"L Victaulic Plastic Adaptors 3"	3"-3"L, Victaulic Plastic Adaptors 3" - Pack Cat.# 113006V075-Pack	6
	V4	Victaulic Plastic Adaptors, 4"	4" Victaulic Plastic Adaptors 4" - Pack Cat.# 113006V100-Pack	6



End Connections

BERMAD develops and supplies a wide range of end connections for the 100 hYflow Series Valves.

These end connections provide full flexibility when designing and installing the valves.

Select your desired end connection option from the table on page 23:

- Plastic Flanges
- Metal Flanges
- Glue-In PVC Adaptors
- Grooved Adaptors

Adaptors can be ordered per valve (2 Kits) or in Packs of 6 - 12 kits.

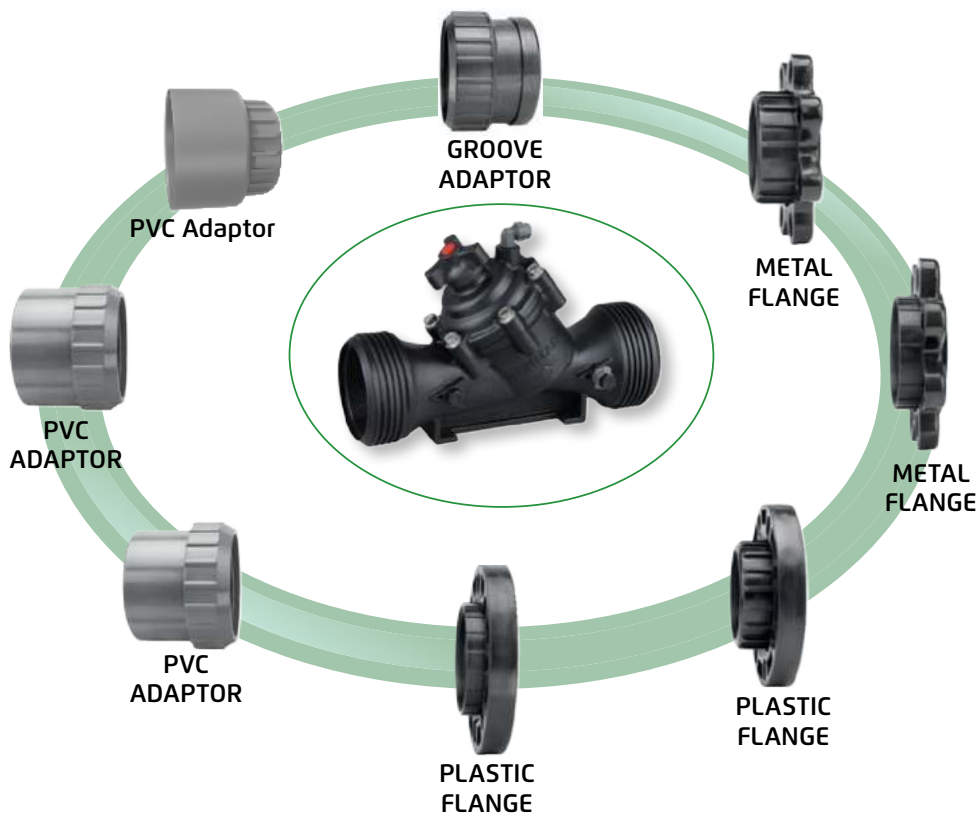

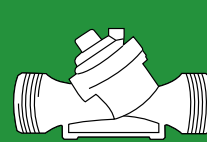

Packing Specifications

1½", 2", 2½", 2"L

3", 3"L

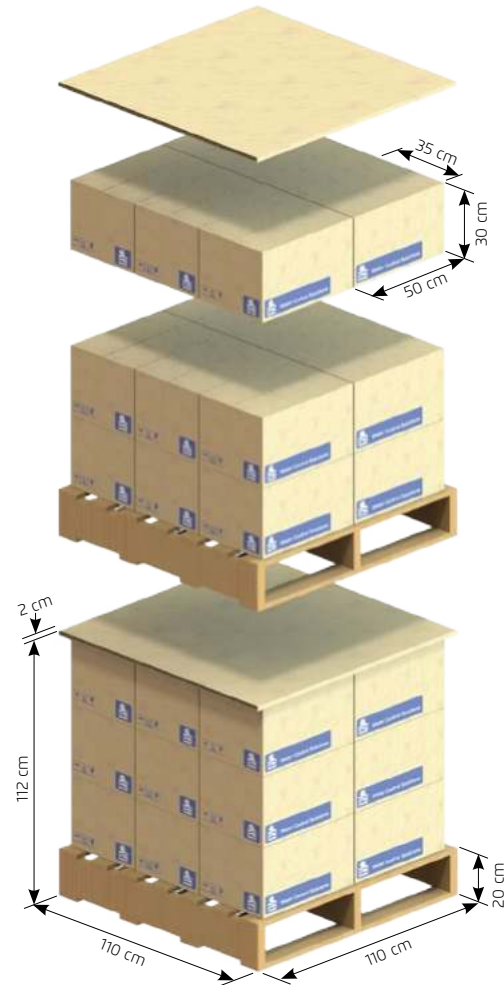
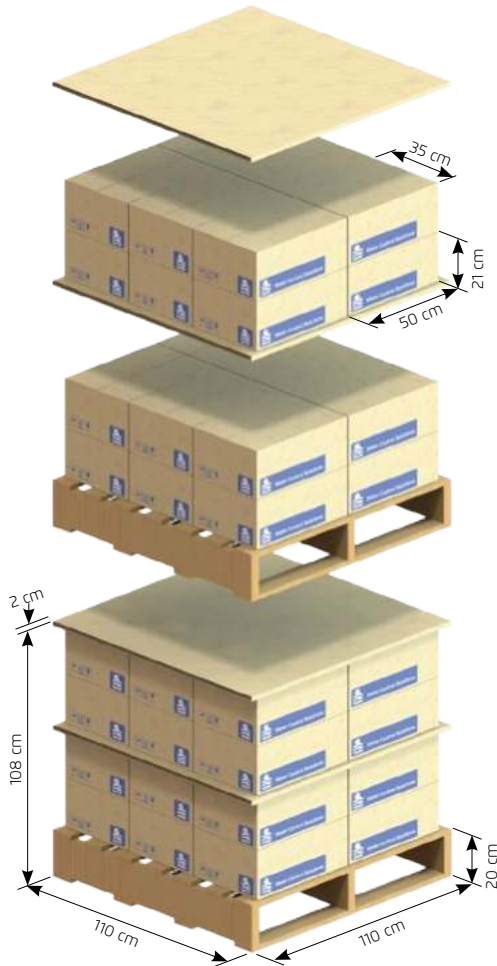

Per Box

Valve Size Single Chamber	Box					
	Units	Length [cm]	Width [cm]	Height [cm]	Weight [kg]	Volume [m³]
1½", 2", 2½"	10	50	35	21	13	0.04
2"L	6	50	35	21	10	0.04
3"	6	50	35	30	10	0.06
3"L	4	50	35	30	13	0.06
4"	1	35	35	25	6	0.04
4"L	4	50	35	30	41	0.06
6"R	2	54	54	48	35	0.14
6"	2	54	54	48	27	0.14

Valve Size Double Chamber	Box					
	Units	Length [cm]	Width [cm]	Height [cm]	Weight [kg]	Volume [m³]
1½"-DC, 2"-DC	10	50	35	21	24	0.04
2"L-DC	6	50	35	21	14	0.04
3"-DC	4	50	35	30	21	0.06



Packing Specifications

4"

6"

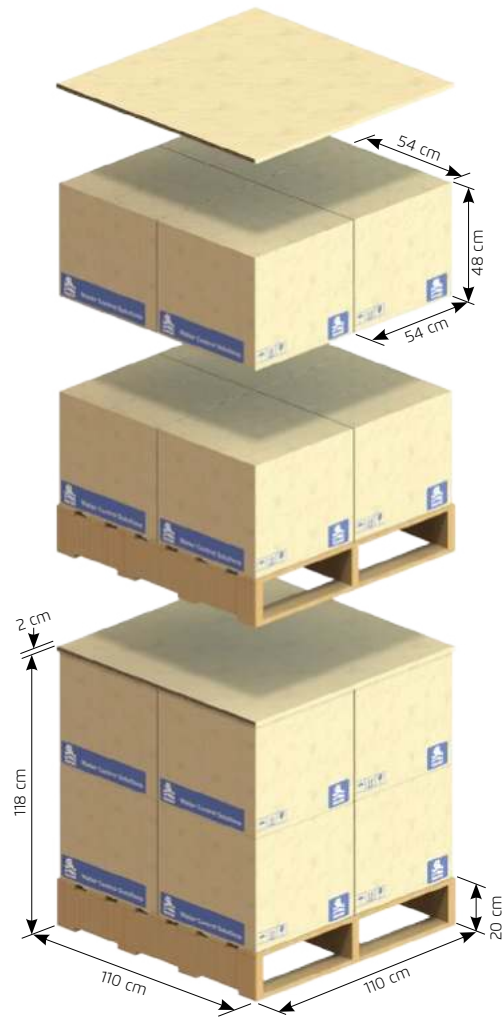
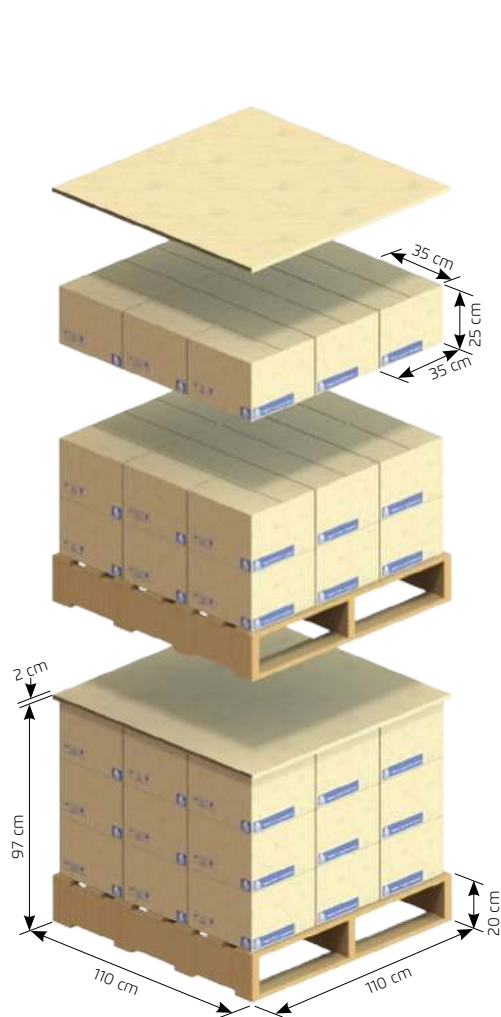

Per Pallet

Valve Size Single Chamber	Pallet						Gross Weight [kg]	Volume [m ³]
	Number of Boxes	Number of Levels	Number of Units	Length [cm]	Width [cm]	Height [cm]		
1½", 2"	24	4	240	110	110	110	335	1.3
2"L	24	4	144	110	110	110	263	1.3
3"	18	3	108	110	110	113	202	1.4
3"L	18	3	72	110	110	113	256	1.4
4"	27	3	27	110	110	98	184	1.2
4"L	18	3	72	110	110	113	760	1.4
6"R	8	2	16	110	110	119	302	1.4
6"	8	2	16	110	110	119	238	1.4

Valve Size Double Chamber	Pallet						Gross Weight [kg]	Volume [m ³]
	Number of Boxes	Number of Levels	Number of Units	Length [cm]	Width [cm]	Height [cm]		
1½"-DC, 2"-DC	24	4	240	110	110	108	598	1.3
2"L-DC	18	3	108	110	110	112	277	1.4
3"-DC	18	3	72	110	110	112	397	1.4





IR-200 Series

The BERMAD IR-200 Series Valves are Composite Material Hydro-Efficient Control Valve, Hydraulic/Electric operated with Flexible Balanced Diaphragm & Seal for agricultural commercial & residential irrigation systems.

The 200 Series range from ½" to 2" in size, in either Globe or Angle pattern. These control valves provide superior hydraulic performance, demonstrating state-of-the-art hydraulics and Composite Material technology.

Features and Benefits

- Spring Loaded Elastomeric Valve
 - Self operated
- Plastic Globe/Angle Hydro-Efficient Valve
 - Unobstructed flow path
 - Single moving part
 - High flow capacity
- Flexible Balanced Diaphragm and Seal
 - Fully opening
 - Secures drip-tight closing
- User-Friendly Design
 - Simple in-line inspection

Typical Applications

- Drip-Tape Systems
- LPS - Low Pressure Systems
- Remote and/or Elevated Plots
- Head Control or Main Control head
- Main & secondary Control Head
- Energy Saving Irrigation Systems
- Computerized Irrigation Systems



On/Off Control

2-Way Internal Electric control

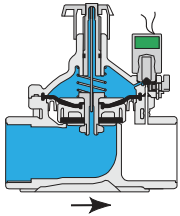

Closed Position

The internal restriction continuously allows line pressure into the control chamber. The solenoid controls outflow from the control chamber. When the solenoid is closed it causes pressure to accumulate in the control chamber, therefore forcing the valve to close.

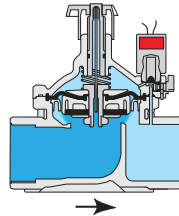

Open Position

Opening the Solenoid releases more flow from the control chamber than the restriction can allow in. This causes the accumulated pressure in the control chamber to drop, enabling the line pressure acting on the plug to the valve.

3-Way Hydraulic Control

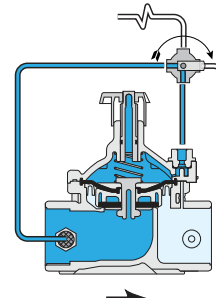

Closed Position

Line pressure applied to the control chamber of the valve creates a superior force that changes the valve position to close, providing drip tight sealing.

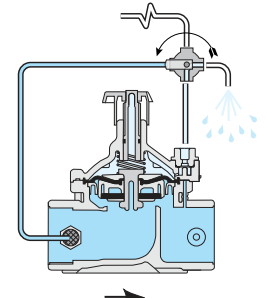

Open Position

Discharging the pressure in the control chamber to atmosphere or some other lower pressure zone causes the line pressure acting on the seal disc to change the valve position to open.

Dimensions & Weights

Pattern	Globe					Angle		
	DN inch	12 1/2	20 3/4	25 1	40 1 1/2	50 2	40 1 1/2	50 2
L (mm)	67	110	110	160	170	80	85	
H (mm)	58	115	115	180	190	190	210	
R (mm)	16	22	22	35	38	40	60	
W (mm)	42.5	78	78	125	125	125	125	
Weight* (Kg)	0.06	0.35	0.33	1.0	1.1	0.95	0.91	
CCDV** (liter)		0.015	0.015	0.072	0.072	0.072	0.072	

* Without flow control handle **Control Chamber Displacement Volume (liter)

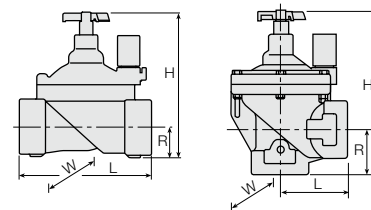

Flow Chart

2-Way circuit "Added Head Loss" (for "V" below 2 m/s): 0.3 bar

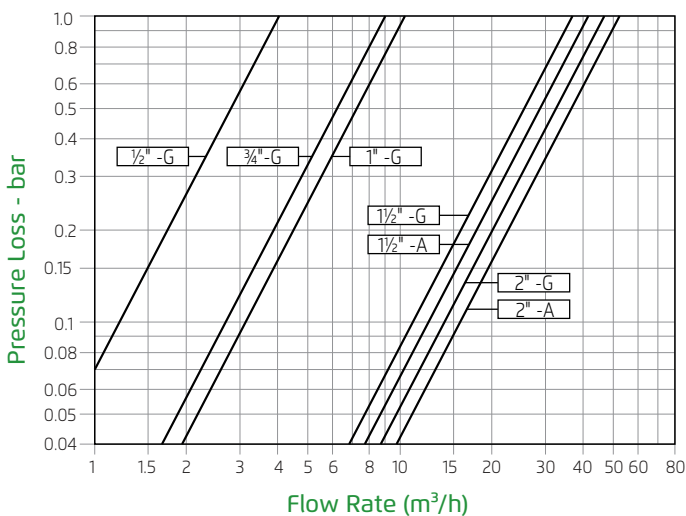

$$\Delta P = \left(\frac{Q}{Kv} \right)^2$$

$Kv = m^3/h @ \Delta P \text{ of } 1 \text{ bar}$ $Cv = 1.155 Kv$
 $Q = m^3/h$
 $\Delta P = \text{bar}$

Technical Specifications

Available Patterns and Sizes:

Globe: 1/2"-2"; DN40-DN50

Angle: 1 1/2" & 2"; DN40 & DN50

Available End Connections: BSP-T; NPT female threads

Pressure Rating: PN10; 150psi

Operating Pressure Range: 0.7-10bar; 10-150psi

Standard Materials:

- **Body and Cover:** Polyamide (Nylon) 6 – 30GF Black
- **Metal Parts:** Stainless Steel
- **Diaphragm:** NBR
- **Seals:** NBR
- **Spring:** Stainless Steel
- **Cover bolts:** Stainless Steel

Size	DN Inch	12 1/2	20 3/4	25 1	40 1 1/2	40 1 1/2	50 2	50 2
Pattern		G	G	G	G	A	G	A
KV		4	9	9	37	41	47	52





IR
1½"
220
55
A
P
BP
4AC
M

Size		
½"	DN12	On/Off
¾"	DN20	
1"	DN25	
1½"	DN40	
2"	DN50	

Primary Features	Code	
Basic Valve	205	
Solenoid Controlled Valve (¾"-2")	210	
Trio Solenoid Controlled Valve (½"-2")	NEW	21T
Pressure Reducing Valve	220	
Pressure Reducing TOP PILOT Valve	NEW	22T
Pressure Reducing & Sustaining Valve	223	
Pressure Sustaining Valve	230	
Differential Pressure Sustaining Valve	236	
Quick Pressure Relief Valve	23Q	
Level Control Valve	250	
Level Control & Pressure Sustaining Valve	253	

Other primary features available on request.

Additional Features	Code
No Additional Features	00
Opening & Closing Speed Control	03
Accelerated Closing	04
Electric Valve, without Solenoid	05
Check feature	20
Solenoid Control & Check Feature	25
N.O. Hydraulic Remote Control	50
N.C With Adjustable Hydraulic Relay	54X
N.C. with Hydraulic Relay	54
Solenoid Controlled	55
Modulating Horizontal Float	60
Green-App Control	G4
Internal Feed & Bleed*	N
TOP PILOT with 12-40 PSI adjusting scale & Spring (2-Way Only)	J1
TOP PILOT with 12-80 PSI adjusting scale & Spring	J2
TOP PILOT with 0.8-3.0 Bar adjusting scale & Spring (2-Way Only)	H1
TOP PILOT with 0.8-6.0 Bar adjusting scale & Spring	H2

* Internal Feed & Bleed options N1-N7 available according to specific Application Engineering definitions.

Pattern	Code
Globe	G
Angle (1½"-2")	A

Construction Materials	Code
Nylon Glass Filled (Standard)	P

End Connections	Code
BSP Female Threaded	BP
NPT Female Threaded	NP
Victaulic Adaptors x BSP (2" only)	VB
Victaulic Adaptors x NPT (2" only)	VN

Voltage-Main Valve Position (When Solenoid De-Energized)	Code
24VAC - Normally Closed	4AC
24VAC - Normally Open	4AO
24VDC - Normally Closed	4DC
24VDC - Normally Open	4DO
12VDC - Normally Closed	1DC
12VDC - Normally Open	1DO
12VDC - Latch Solenoid S-985 (3 Leads)	1DS
12VDC - Latch Solenoid S-982 (2 Leads)	2DS
9VDC - Latch Solenoid	9DS

Other electrical ratings available on request.

Additional Attributes Unlimited Selection	Code
Servo (2/3-Way Control Loop)	b
3-Way Control Loop	X
External Control Pressure	e
EPDM Elastomers Seals & Diaphragm	E1
Flow Stem	M
Manual Selector	Z
Low Preset Pressure (below 2 bar)	2
Plastic Pressure Test Point	5
½" Anti Vacuum at Valve Downstream	7

Other additional attributes are optional. Please consult Customer Service for further information.



Hydraulic Control Basic Valve

IR-205

Size	Pattern	Connection
1/2"	DN16	G Threaded

New



Hydraulic Control Valve

with Flow Stem

IR-205-M

Size	Pattern	Connection
3/4"	DN20	G Threaded
1"	DN25	G Threaded
1 1/2"	DN40	G Threaded

Size	Pattern	Connection
1 1/2"	DN40	A Threaded
2"	G	Threaded
	A	Threaded



Hydraulic Control Valve

with Flow Stem & Manual Selector

IR-205-MZ

Size	Pattern	Connection
3/4"	DN20	G Threaded
1"	DN25	G Threaded
1 1/2"	DN40	G Threaded

Size	Pattern	Connection
1 1/2"	DN40	A Threaded
2"	G	Threaded
	A	Threaded



Trio Solenoid Controlled Valve

with 2-Way Control

IR-21T-2W

Solenoid S-390-T-2W

Size	Pattern	Connection
1/2"	DN16	G Threaded

New

(*) Standard 24V AC. For other voltage see Ordering Guide





Trio Latching Solenoid Controlled Valve

with 2-Way Control

IR-21T-LS-2W

S-392-T-2W 6-20V/DC Latch

Size	Pattern	Connection
1/2"	DN16	G Threaded

New



Trio Solenoid Controlled Valve

with 2-Way Internal Control, Flow Stem

IR-21T-M-2W

Solenoid S-390-T-2W

Size	Pattern	Connection
3/4"	DN20	G Threaded
1"	DN25	G Threaded
1 1/2"	DN40	G Threaded

Size	Pattern	Connection
1 1/2"	DN40	A Threaded
2"	G	Threaded
	A	Threaded

New



(*) Standard 24V AC. For other voltage see Ordering Guide

Solenoid Controlled Valve

with 3-Way Controls, Flow Stem

IR-210-MX

Solenoid S-390-3W

Size	Pattern	Connection
3/4"	DN20	G Threaded
1"	DN25	G Threaded
1 1/2"	DN40	G Threaded

Size	Pattern	Connection
1 1/2"	DN40	A Threaded
2"	G	Threaded
	A	Threaded

(*) Standard 24V AC. For other voltage see Ordering Guide



Solenoid Controlled Valve, N.O.

with 3-Way Control, Internal Feed & External Bleed

IR-210-N7-NO-MX

Solenoid S-390-3W

Size	Pattern	Connection
3/4"	DN20	G Threaded
1"	DN25	G Threaded
1 1/2"	DN40	G Threaded

Size	Pattern	Connection
1 1/2"	DN40	A Threaded
2"	G	Threaded
	A	Threaded

(*) Standard 24V AC. For other voltage see Ordering Guide



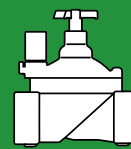

Trio Latching Solenoid Controlled Valve

with 2-Way Control

IR-21T-LS-M-2W

Solenoid S-392-T-2W 6-20V/DC Latch

Size	Pattern	Connection
3/4"	DN20	G Threaded
1"	DN25	G Threaded
1 1/2"	DN40	G Threaded

Size	Pattern	Connection
1 1/2"	DN40	A Threaded
2"	DN50	G Threaded
		A Threaded

New



GreenApp Controlled Valve

Application Operated

IR-21T-GreenApp

Size	Pattern	Connection
3/4"	DN20	G Threaded
1"	DN25	G Threaded
1 1/2"	DN40	G Threaded

Size	Pattern	Connection
1 1/2"	DN40	A Threaded
2"	DN50	G Threaded
		A Threaded

New



Latching Solenoid Controlled Valve

with 3-Way Control, Flow Stem

IR-210-LS-MX

Solenoid S-392-T-3W

Size	Pattern	Connection
1 1/2"	DN40	G Threaded
		A Threaded

Size	Pattern	Connection
2"	DN50	G Threaded
		A Threaded



Top Pilot Pressure Reducing Valve

with 2-Way Control

IR-22T-M-2W

Size	Pattern	Connection
1 1/2"	DN40	G Threaded
		A Threaded

Size	Pattern	Connection
2"	DN50	G Threaded
		A Threaded

New





Pressure Reducing Valve

with 2-Way Control, Flow Stem

IR-220-M-2W

Size		Pattern	Connection
1½"	DN40	G	Threaded
		A	Threaded

Size		Pattern	Connection
2"	DN50	G	Threaded
		A	Threaded



Pressure Reducing Valve

with 3-Way Control, Manual Selector and Flow Stem

IR-220-MXZ

Size		Pattern	Connection
1½"	DN40	G	Threaded
		A	Threaded

Size		Pattern	Connection
2"	DN50	G	Threaded
		A	Threaded



Pressure Reducing Valve

2/3-Way (Servo) Control, Manual Selector

IR-220-MZb

Size		Pattern	Connection
1½"	DN40	G	Threaded
		A	Threaded

Size		Pattern	Connection
2"	DN50	G	Threaded
		A	Threaded



Top Pilot Pressure Reducing Valve

with 2-Way Solenoid Control

IR-22T-55-M

Solenoid S-390-T-2W

Size		Pattern	Connection
1½"	DN40	G	Threaded
		A	Threaded

Size		Pattern	Connection
2"	DN50	G	Threaded
		A	Threaded

(*) Standard 24V AC. For other voltage see Ordering Guide





Pressure Reducing Valve

with 2-Way Solenoid Control

IR-220-55-M

Solenoid S-390-T-2W

Size		Pattern	Connection	Size		Pattern	Connection
1 1/2"	DN40	G	Threaded	2"	DN50	G	Threaded
		A	Threaded			A	Threaded

(*) Standard 24V AC. For other voltage see Ordering Guide



Pressure Reducing Valve

with 3-Way Solenoid Control

IR-220-55-MX

Solenoid S-390-3W

Size		Pattern	Connection	Size		Pattern	Connection
1 1/2"	DN40	G	Threaded	2"	DN50	G	Threaded
		A	Threaded			A	Threaded



Pressure Reducing Valve

2/3W (Servo) Control, 3-Way Solenoid Control

IR-220-55-Mb

Solenoid S-390-3W 24V/AC

Size		Pattern	Connection	Size		Pattern	Connection
1 1/2"	DN40	G	Threaded	2"	DN50	G	Threaded
		A	Threaded			A	Threaded



Pressure Sustaining Valve, 2-Way

with 2-Way Control

IR-230-M-2W

Size		Pattern	Connection	Size		Pattern	Connection
1 1/2"	DN40	G	Threaded	2"	DN50	G	Threaded
		A	Threaded			A	Threaded





Pressure Sustaining Valve, 3-Way

with 3-Way Control, Manual Selector

IR-230-MXZ

Size	Pattern	Connection
1½"	DN40	G Threaded
	A	Threaded

Size	Pattern	Connection
2"	DN50	G Threaded
	A	Threaded



Pressure Sustaining Valve

with 2-Way Solenoid Control

IR-230-55-M-2W

Solenoid S-390-T-2W

Size	Pattern	Connection
1½"	DN40	G Threaded
	A	Threaded

Size	Pattern	Connection
2"	DN50	G Threaded
	A	Threaded



Pressure Sustaining Valve

with 3-Way Solenoid Control

IR-230-55-MX

Solenoid S-390-3W

Size	Pattern	Connection
1½"	DN40	G Threaded
	A	Threaded

Size	Pattern	Connection
2"	DN50	G Threaded
	A	Threaded



Additional Features & Options - Suffix Code

Code	Description
50-3W-P	Hydraulic Control (T Selector Shuttle Valve) - Plastic
50-2W-P	Hydraulic Control (2-Way Hydraulic Relay) - Plastic
54-3W-P	3-Way Hydraulic Relay (3W-HRV) ½" - Plastic
55	Solenoid Controlled
Z	Manual Selector
5*	Plastic Test Point

* Plastic Test Point is Standard for all regulating valves.

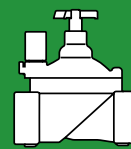

Packing Specifications

3/4", 1"

1 1/2", 2"

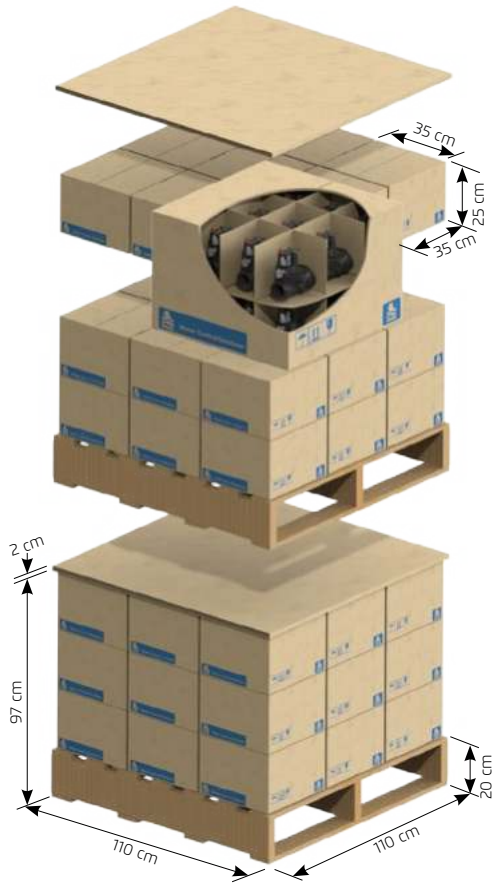

Per Box

Valve Size	Box					
	Units	Length [cm]	Width [cm]	Height [cm]	Weight [kg]	Volume [m ³]
1/2"	24	35	35	25	5.4	0.05
3/4"	24	35	35	25	8.5	0.05
1"	24	35	35	25	8.5	0.03
1 1/2"	12	50	35	30	12.4	0.05
2"	12	50	35	30	13.8	0.05

Per Pallet

Valve Size	Pallet							
	Number of Boxes	Number of Levels	Number of Units	Length [cm]	Width [cm]	Height [cm]	Gross Weight [kg]	Volume [m ³]
1/2"	18	3	432	110	110	97	116	1.2
3/4"	27	3	648	110	110	97	251	1.2
1"	27	3	648	110	110	97	251	1.2
1 1/2"	18	3	216	110	110	112	209	1.4
2"	18	3	216	110	110	112	227	1.4





IR-350 Series

The BERMAD IR-350 Series Valves are the benchmark of BackWash valves, consisting of compact 3-port valves, in a "T" configuration. They are double chambered, hydraulically operated, and diaphragm actuated.

Designed for automatic backwashing of filtration systems, valves are available in Angle flow (A) and Straight flow (S) configurations. The IR-350 is a double-chambered valve with long valve travel resulting in: Protected diaphragm, higher flow, quick & smooth mode change, and eliminating mixing of supply & wastewater.

Available in sizes of 2"x2", 3"x3/2", 3"x3" 4"x4/3", 4"x4" Composite Materials.



Angle Flow



Straight Flow

Features and Benefits

- Line Pressure Driven
- Double Chambered Design
 - Quick and smooth mode change
 - Wide application range
 - Requires low actuation pressure
 - Protected diaphragm
- Dynamic Sealing
 - Seals at very low pressure
 - Prevents seal friction and erosion
- Engineered Plastic Valve Design
 - Highly durable, chemical and cavitation resistant
- Long Valve Travel
 - Higher flow and lower head loss
 - Smooth changes of flow direction
 - Eliminates mixing of supply and wastewater
- User- Friendly
 - Can be installed in various orientations
 - Simple in-line inspection and service

Typical Applications

- Automatic Backwash of Filter Batteries
 - Gravel Filters
 - Sand Filters
 - Disc Filters
 - Screen Filters
- Single Filter Autonomic Backwash System
- Angled or Straight Installations
- Backwash Flow Limit (IR-470-beKU, IR-170-beU)



Dimensions & Weights

Dimensions	2"x2"-P	2"x2"-P grooved	3"x3"-P	4"x4"-P
H [mm]	274	274	378	464
C [mm]	90	116	143.5	138.5
Z [mm]	90	116	143.5	178.5
W [mm]	126	126	160.5	150
1 [mm]	127	153	189	225
U [mm]	80	80	96	130
weight [kg]	2.7	3.2	5.1	9.9

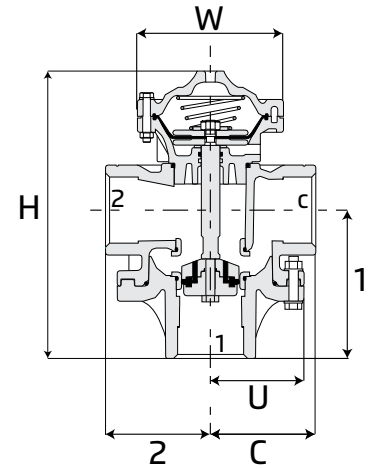

Hydraulic Data

			2"x2"-P	3"x3"-P	4"x4"-P
angle flow					
	filtration 1-C	kv	52	110	225
	backwash C-2	kv	48	100	205
straight flow					
	filtration 2-C	kv	46	93	190
	backwash C-1	kv	60	122	250

$$\Delta P = \left(\frac{Q}{Kv} \right)^2$$

$Kv = m^3/h @ \Delta P \text{ of } 1 \text{ bar}$
 $Q = m^3/h$
 $\Delta P = \text{bar}$
 $Cv = 1.155 Kv$

Flow Chart

Angle Flow

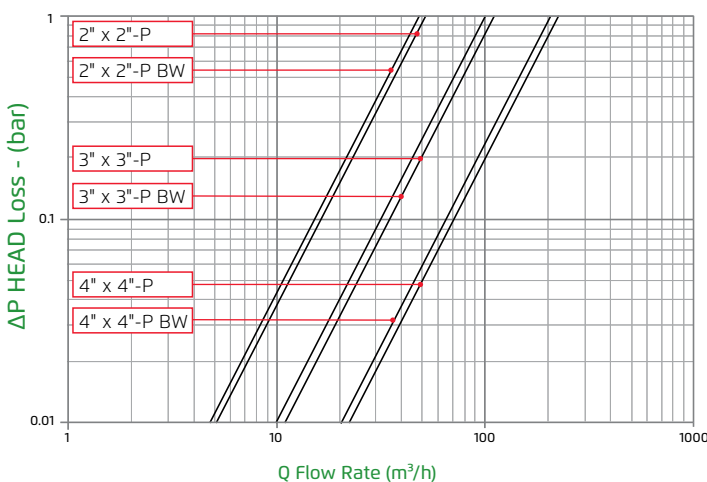

Straight Flow

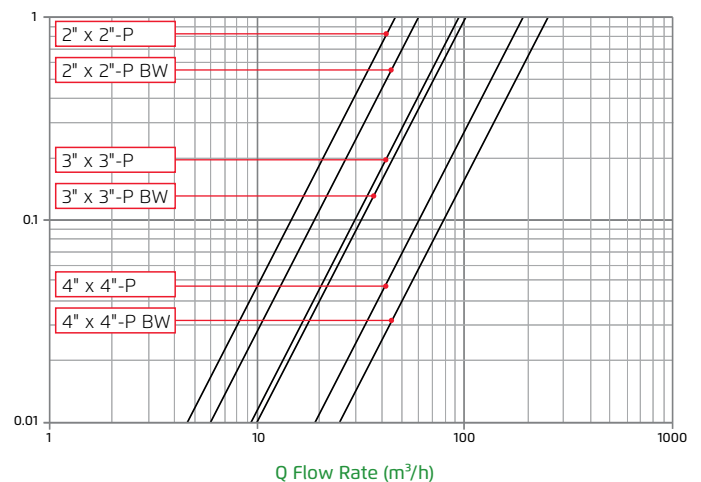



Technical Data

Control Chamber Displacement Volume:

2"x2": 0.13 liter; 0.03 gallon; **3"x3"**: 0.34 liter; 0.09 gallon; **4"x4"**: 0.55 liter; 0.15 gallon

Standard Valve : 1.5-10 bar ; 22-150 psi

External Operating Pressure: 85%-100% of operating pressure

Maximum Temperature: 65°C;150°F

Flow Patterns: Angled Flow, Reverse Angled Flow, Straight Flow, Reverse Straight Flow

End Connections: All threads are BSP

Size	Port C	Port 2	Port 1
2"x2"	<ul style="list-style-type: none"> • Threaded 2" • Grooved 2" (with adaptors) 	<ul style="list-style-type: none"> • Threaded 2" • Grooved 2" (with adaptors) 	<ul style="list-style-type: none"> • Threaded 2" • Grooved 2" (with adaptors)
3"x3" 3"x3"/2"	<ul style="list-style-type: none"> • Grooved 3" 	<ul style="list-style-type: none"> • Grooved 3" 	<ul style="list-style-type: none"> • Grooved 3" • Grooved 3" x Int. Thread 2"
4"x4" 4"x4"/3"	<ul style="list-style-type: none"> • Grooved 4" 	<ul style="list-style-type: none"> • Grooved 4" 	<ul style="list-style-type: none"> • Grooved 4" • Union Connector (Havazelet) 75mm • Grooved 4" x Int. Thread 3"

Materials

Valve Body:

Plastic: Polyamide 6 – 30GF Black All Sizes

Separating Partition & Lower Adaptor: Polyamide 6 – 30GF Black

Cover: Polyamide 6 – 30GF (Angle Flow – Black; Straight Flow – Grey)

Diaphragm: NR-AL52 Nylon Fabric Reinforced

Seats: Stainless Steel 304

Plugs: Acetal Copolymer Black (drilled) / Grey (undrilled)

Seal, O-Rings: NBR

Spring: Stainless Steel AISI 302

Shaft: Stainless Steel AISI 303

External Bolts, Studs, Nuts & Discs: Stainless Steel



IR **3"x3"** **350-55** **A** **P** **P** **VI** **UC** **4AC** **PP** **Z**

Size	
2"x2"	DN50x50
3"x3" 3"x3/2" ⁽¹⁾	DN80x80 DN80x80/50
4"x4" 4"x4/3" ⁽²⁾	DN100X100

(1) ■ Straight flow only
 ■ Port 1 (drain) is 3" grooved and 2" female threaded

(2) ■ Straight flow only
 ■ Port 1 (drain) is 4" grooved and 3" female threaded

Port 1 (Lower Seat) Connection		Code
BSP Threaded Female		P
Grooved		V
"Havazelet" (4"x4" Only)		H

Coating		Code
Uncoated		UC

Port 2 / C Connections		Code
Grooved ANSI C 606-81 Steel Pipe		VI
BSP Threaded Female 2"x2" only		BP

Optional 2" Adaptors are available on request:

- BSP Male Threaded x Grooved (when Grooved is required).
- BSP Male Threaded x NPT Female Threaded (when NPT is required).

Voltage-Main Valve Position (When Solenoid De-Energized)		Code
24VAC - Normally Open		4AC
24VDC - Normally Open		4DO
12VDC - Normally Open		1DO
12VDC - Latch Solenoid S-985 (3 Leads)		1DS
12VDC - Latch Solenoid S-982 (2 Leads)		2DS
9VDC - Latch Solenoid		9DS

Other electrical ratings available on request.

Primary Features		Code
Filter Backwash Valve		350
Filter Backwash Valve with Hydraulic Accelerator		350-54
Filter Backwash Valve, Solenoid Controlled		350-55

Other primary features available on request.

Pattern / Flow Options		Code
Angle Flow		A
Straight Flow		S
Angle & Reverse Flow		A-0
Straight & Reverse Flow		S-0

Body Material		Code
Nylon - G.F.		P

Voltage-Main Valve Position (When Solenoid De-Energized)		Code
24VAC - Normally Open		4AC
24VDC - Normally Open		4DO
12VDC - Normally Open		1DO
12VDC - Latch Solenoid S-985 (3 Leads)		1DS
12VDC - Latch Solenoid S-982 (2 Leads)		2DS
9VDC - Latch Solenoid		9DS

Other electrical ratings available on request.

Tubing & Fittings		Code
Plastic Tubing & Fittings		PP

Additional Attributes Unlimited Selection		Code
EPDM Elastomers Seals & Diaphragm		E1
Viton Elastomers Seals & Diaphragm		E2
Metal Control Accessories		R
Stainless Steel 316 Seat & Shaft		T
Manual Selector		Z
Plastic Gauge Test Point		5

Other additional attributes are optional.





Filter Backwash Hydraulic Valve, 2X2 Plastic - Double Chamber

IR-2X2-350-P

Model	Description	Cover
Angle Flow	IR-2"x2"-A-P-P-Threaded-UC	Black
Straight Flow	IR-2"x2"-S-P-P-Threaded-UC	Grey
Angle & Reverse Flow	IR-2"x2"-A-O-P-P-Threaded-UC	Black
Straight & Reverse Flow	IR-2"x2"-S-O-P-P-Threaded-UC	Grey
2" Grooved- Threaded Connectors*	Plastic (Add on)	-

* Supplied as part of configured valve. Add on prices for 3 kits per valve.



Filter Backwash Hydraulic Valve, 3X3 Plastic - Double Chamber

IR-3X3-350-P

Model	Description	Cover
Angle Flow	IR-3"x3"-A-P-V-VI-UC	Black
Straight Flow	IR-3"x3"-S-P-V-VI-UC	Grey
Angle & Reverse Flow	IR-3"x3"-A-O-P-V-VI-UC	Black
Straight & Reverse Flow	IR-3"x3"-S-O-P-V-VI-UC	Grey



Filter Backwash Hydraulic Valve, 4X4 Plastic - Double Chamber

IR-4X4-350-P

Model	Description	Cover
Angle Flow	IR-4"x4"-A-P-V-VI-UC	Black
Straight Flow	IR-4"x4"-S-P-V-VI-UC	Grey
Angle & Reverse Flow	IR-4"x4"-A-O-P-V-VI-UC	Black
Straight & Reverse Flow	IR-4"x4"-S-O-P-V-VI-UC	Grey



Filter Backwash Hydraulic Valve, 3X2 Metal Body - Double Chamber

IR-3X2-DC-A-I

Model	Description	Cover
Angle Flow	IR-3"x2"-DC-A-I-P-VI-PG	Black
Angle & Reverse Flow	IR-3"x2"-DC-A-O-I-P-VI-PG	Black





Packing Specifications

2"x2"x2" Plastic

3"x3"x3" Plastic
4"x4"x4" Plastic

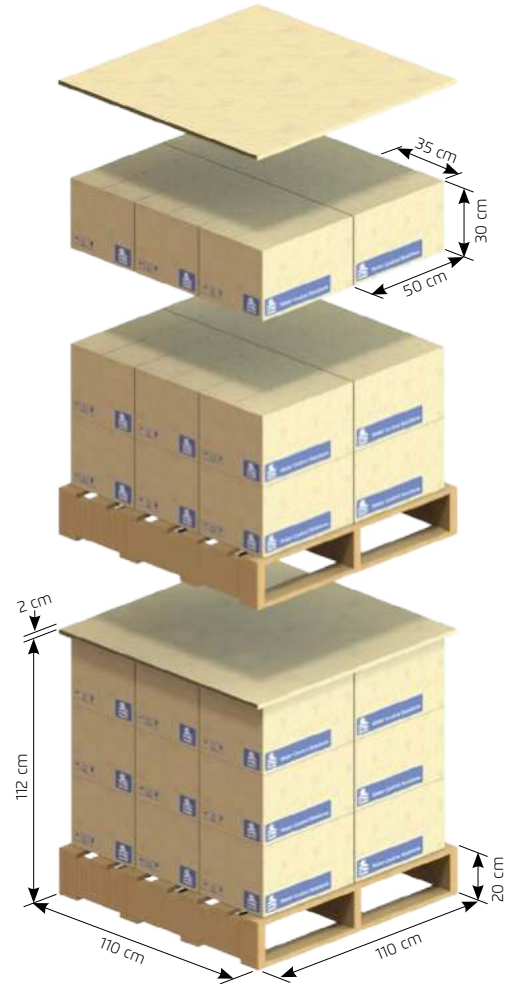
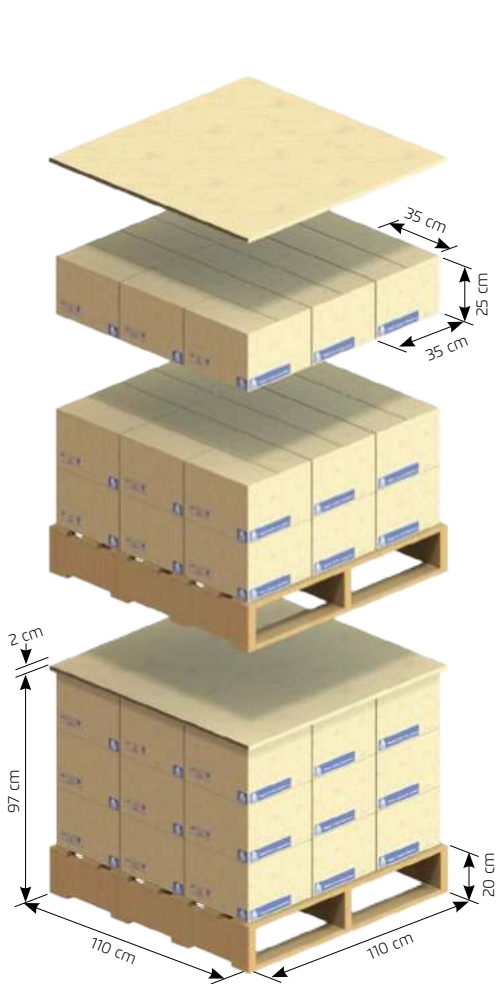

Per Box

Valve Size	Box					
	Units	Length [cm]	Width [cm]	Height [cm]	Weight [kg]	Volume [m ³]
2"x2"x2" Plastic	2	35	35	25	6.144	0.03
3"x3"x3" Plastic	2	50	35	30	11.76	0.05
4"x4"x4" Plastic	1	50	35	30	11.02	0.05

Per Pallet

Valve Size	Pallet							
	Number of Boxes	Number of Levels	Number of Units	Length [cm]	Width [cm]	Height [cm]	Gross weight [kg]	Volume [m ³]
2"x2"x2" Plastic	27	3	54	110	110	97	186	1.2
3"x3"x3" Plastic	18	3	36	110	110	112	231	1.4
4"x4"x4" Plastic	18	3	18	110	110	112	218	1.4



IR-400 Series



The IR-400 Series Valves are virtually free of the typical limitations associated with other diaphragm single chambered valves.

The body design includes a full bore seat with unobstructed flow path. The internal design is using advanced rubber-based materials to achieve a solid, one piece elastomeric assembly including a flexible diaphragm, vulcanized with a rugged radial seal Disc. The diaphragm is carefully balanced and peripherally supported to avoid distortion and to protect the elastomer, resulting in long-life and controlled actuation even under harsh conditions. One diaphragm and spring fully meet the valve's operating pressure range requirements.

The IR-400 Series Valves are available in diameter sizes from 1"-16"; DN25 - DN400.

Features and Benefits

- Hydraulic Control Valve
 - Line pressure driven
 - Hydraulically controlled On/Off
- Advanced Globe Hydro-Efficient Design
 - Unobstructed flow path
 - Single moving part
 - High flow capacity
- Fully Supported & Balanced Diaphragm
 - Requires low opening and actuation pressure
 - Progressively restrains valve closing
 - Prevents diaphragm distortion
- User-Friendly Design
 - Simple in-line inspection
 - Easy addition of control features

Typical Applications

- Computerized Irrigation Systems
- Distribution Centers
- LPS - Low Pressure Systems
- Level Control Valves
- Filter Stations



Technical Specifications

Connections Standard:

Flanged: ISO 7005-2 (PN10 & 16)

Threaded: BSP; NPT

Grooved: ANSI C606

Operating Pressure Ranges:

IR-400: 0.5-16 bar

For lower pressure requirements, consult factory

GR-400: 0.5-10 bar

Temperature: Water up to 60°C

Standard Materials:

Castings & Forgings:

- Cast Iron to EN 1561

- Ductile Iron to EN 1563

- Brass

Elastomers: NR to EN 681-1

Coatings: Electrostatic Powder Coating Polyester

Dimensions & Weights

Globe Pattern

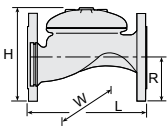

Connection Type	Flange													
	Size	DN	50	65	80R	80	100	125	150	200	250	300	350	400
		inch	2	2½	3R	3	4	5	6	8	10	12	14	16
L			205	205	210	250	320	320	415	500	605	725	742	741
H			155	178	200	210	242	254	345	430	460	635	655	694
W			155	178	200	200	223	197	306	365	405	580	587	587
R			78	89	100	100	112	127	140	170	202	242	260	300
Weight (Kg)			9	10.5	12.1	19	28	33	68	125	140	290	358	377

Connection Type	Threaded						Grooved					
	Size	DN	25	40	50	65	80R	80	50	80	100	150
		inch	1	1½	2	2½	3R	3	2	3	4	6
L			115	153	180	210	210	255	205	250	320	415
H			68	87	114	132	140	165	108	155	191	302
W			71	98	119	129	129	170	119	170	204	306
R			34	29	39	45	53	55	31	46	61	85
Weight (Kg)			1.1	2	4	5.7	5.8	13	5	10.6	16.2	49

Angle Pattern

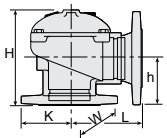

Connection Type	Threaded				Grooved		Flanged				
	Size	DN	50	65	80R	80	80	100	50	80	100
		inch	2	2½	3R	3	3	6	2	3	4
L			86	110	110	110	120	160	121	153	160
H			136	180	178	184	194	223	160	205	223
W			119	131	131	170	170	204	155	200	223
h			61	93	91	80	90	112	83	101	112
K			56	66	66	55	45	58	78	100	112
Weight (Kg)			4.4	5.8	7	11	10	16	9	17	26

Globe Pattern

2-Way circuit "Added Head Loss" (for "V" below 2 m/s; 0.3 bar)

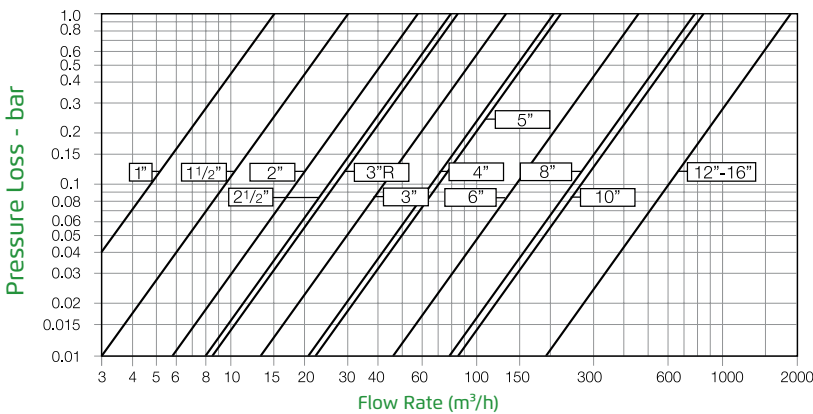

Angle Pattern

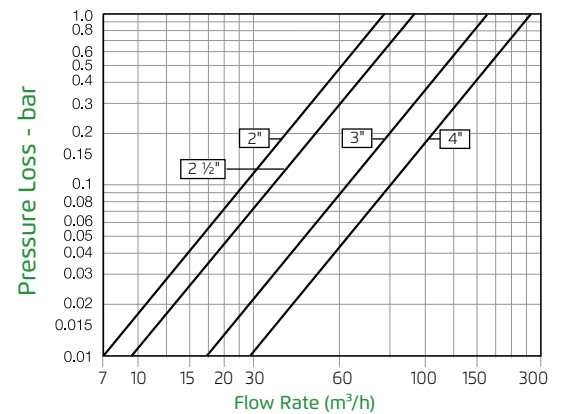

Size	DN	25	40	50	50	65	65	80	80	100	100	150	200	250	300	350	400
	Inch	1	1½	2	2	2½	2½	3	3	4	4	6	8	10	12	14	16
Pattern		G	G	G	A	G	A	G	A	G	A	G	G	G	G	G	G
KV		13	57	57	71	78	88	136	152	204	225	458	781	829	1,932	1,932	1,932





IR
3"
420
55
00
G
I

IR	Code
Irrigation	IR

Size	
1"	DN25
1 1/2"	DN40
2"	DN50
2 1/2"	DN65
3"R	DN80R
3"	DN80
4"	DN100
5" R	DN125R
6"	DN150
8"	DN200
10"	DN250
12"	DN300
14"	DN350
16"	DN400

Primary Features	Code
Basic Valve	405
Solenoid Controlled Valve	410
Electronic Control Valve	418
Pressure Reducing Valve	420
Pressure Reducing & Sustaining Valve	423
Pressure Sustaining Valve	430
Surge Anticipating Valve	435
Differential Pressure Sustaining Valve	436
Quick Pressure Relief Valve	43Q
Level Control Valve	450
Level Control & Pressure Sustaining Valve	453
Level & Flow Control Valve	457
Flow Control Valve	470
Flow Control & Pressure Reducing Control Valve	472
Flow Control & Pressure Sustaining Control Valve	473
Flow Control, Pressure Reducing & Sustaining Valve	475

Other primary features available on request.

Additional Features (Multiple Choices Permitted)		Code
No Additional Feature		00
Closing and Opening-Speed-Control		03
Accelerated Closing		04
Hydraulic Override		09
Electronic Control		18
Check Feature		20
Solenoid Controlled & Check Feature		25
Relief Override		3Q
Electrically Selected Multi-Level Setting		45
Downstream Over Pressure Guard		48
Closing Surge Prevention		49
N.O. Hydraulic Remote Control		50
N.C With Adjustable Hydraulic Relay		54X
N.C. with Hydraulic Relay		54
Solenoid Controlled		55
Electric Override		59
Modulating Horizontal Float		60
Bi-Level Electric Float		65
Bi-Level Vertical Float		66
Modulating Vertical Float		67
Altitude Pilot		80*
Setting Range	2-6 meter; 7-20 feet Setting	M1
	2-14 meter; 7-46 feet Setting	M6
	5-22 meter; 17-72 feet Setting	M5
	15-35 meter; 49-115 feet Setting	M4
	25-70 meter; 82-230 feet Setting	M8

* Select Setting Range
Other additional features available on request.

Pattern	Code
Globe	G
Angle (2"-4")	A

Construction Materials	Code
Cast Iron (up to 8")	I
Ductile Iron (10" and above)	C

Other materials available on request.





End Connections		Code	
Threaded	BSP Female Threaded	1"-3"	BP
	NPT Female Threaded		NP
Flanged	ISO-10	2"-16"	10
	ISO-16		16
	IS 14 (ISO 10/4 Holes, 3")		14
	ANSI-125		A1
	ANSI-150		A5
	BST-D		BD
	JIS-10		J1
	ABNT-10		B1
ABNT-16	B6		
Grooved	ANSI C 606-81, Steel Pipe (Globe - 2", 3", 4", 6" & 8"; Angle - 3" & 4")	VI	

Other end connections available on request.

Coating	Code
Polyester Green RAL 6017	PG

Voltage-Main Valve Position (When Solenoid De-Energized)	Code
24VAC, with Diode (D) - Normally Closed	4AC
24VAC, with Diode (D) - Normally Open	4AO
24VAC - Last Position	4AP
24VAC, with Ring (R) - Normally Closed	4RC
24VAC, with Ring (R) - Normally Open	4RO
24VDC - Normally Closed	4DC
24VDC - Normally Open	4DO
24VDC - Last Position	4DP
12VDC - Normally Closed	1DC
12VDC - Normally Open	1DO
12VDC - Last Position	1DP
12VDC - Latch Solenoid S-985 (3 Leads)	1DS
12VDC - Latch Solenoid S-982 (2 Leads)	2DS
9VDC - Latch Solenoid	9DS

Other electrical ratings available on request.

Tubing & Fittings	Code
Plastic Tubing & Fittings	PP
Plastic Reinforced Tubing & Brass Fittings	PB
Copper Tubing & Brass Fittings	CB

Additional Attributes Unlimited Selection	Code
Servo (2/3-Way Control Loop)	b
3-Way Control Loop	X
Plastic Control Accessories	K
Metal Control Accessories	R
External Control Pressure	e
EPDM Elastomers Seals & Diaphragm	E1
Large Control Filter	F
Valve Position Indicator *	I
Flow Stem *	M
Electric Limit Switch *	S
Orifice Assembly	U
Paddle Flow Control Pilot (1/2" Upstream Port)	V
Manual Selector	Z
Low Preset Pressure (below 2 bar)	2
High Upstream Pressure (above 10 bar)	3
Plastic Pressure Test Point	5
Pressure Gauge	6
1/2" Anti Vacuum at Valve Downstream	7

* Standard Irrigation Cover & Diaphragm are not suitable for Attributes I, M, S.

Other additional attributes are optional.

Please consult Customer Service for further information.



Hydraulic Control Basic Valve

IR-405

Size	Pattern	Connection
1"	DN25	G Threaded
1½"	DN40	G Threaded
2"	DN50	G Threaded
		G Flanged
		G Grooved
		A Threaded
2½"	DN65	A Flanged
		G Threaded
3"R	DN80R	G Flanged
		A Threaded
3"	DN80	G Threaded
		G Flanged

Size	Pattern	Connection
3"	DN80	G Grooved
		A Threaded
4"	DN100	A Flanged
		G Flanged
6"	DN150	G Grooved
		G Flanged
8"	DN200	G Grooved
		G Flanged
10"	DN250	G Flanged
12"	DN300	G Flanged
14"	DN350	G Flanged
16"	DN400	G Flanged



Hydraulic Control Valve

with Manual Selector, Plastic Fittings (K)

IR-405-KZ

Size	Pattern	Connection
1"	DN25	G Threaded
1½"	DN40	G Threaded
2"	DN50	G Threaded
		G Flanged
		G Grooved
		A Threaded
2½"	DN65	A Flanged
		G Threaded
3"R	DN80R	G Flanged
		A Threaded

Size	Pattern	Connection
3"R	DN80R	G Flanged
		A Threaded
3"	DN80	A Threaded
		G Flanged
4"	DN100	G Grooved
		A Flanged
6"	DN150	G Flanged
		G Grooved



Hydraulic Control Valve

with Manual Selector, Metal Fittings (R)

IR-405-RZ

Size	Pattern	Connection
1"	DN25	G Threaded
1½"	DN40	G Threaded
2"	DN50	G Threaded
		G Grooved
		G Flanged
		A Threaded
2½"	DN65	A Flanged
		G Threaded
3"R	DN80R	G Flanged
		A Threaded
3"	DN80	G Threaded
		G Grooved

Size	Pattern	Connection
3"	DN80	G Flanged
		A Threaded
4"	DN100	A Flanged
		G Grooved
6"	DN150	G Flanged
		A Flanged
8"	DN200	G Grooved
		G Flanged
10"	DN250	G Flanged
12"	DN300	G Flanged
14"	DN350	G Flanged
16"	DN400	G Flanged





Hydraulic Control Valve

with 3-Way Hydraulic Relay, Plastic Accessories (K)

IR-405-54-KX

Size	Pattern	Connection
1"	DN25	G Threaded
1½"	DN40	G Threaded
2"	DN50	G Threaded
		G Flanged
		G Grooved
		A Threaded
2½"	DN65	A Flanged
		A Threaded
3"R	DN80R	G Threaded

Size	Pattern	Connection
3"R	DN80R	G Flanged
		A Threaded
3"	DN80	G Threaded
		G Flanged
		G Grooved
		A Threaded
4"	DN100	A Flanged
		A Threaded
6"	DN150	G Flanged



Solenoid Controlled Valve

with 3-Way Control, Plastic Accessories (K)

IR-410-KX

Solenoid S-390-3W; S-400

Size	Pattern	Connection
1"	DN25	G Threaded
1½"	DN40	G Threaded
2"	DN50	G Threaded
		G Flanged
		G Grooved
		A Threaded
2½"	DN65	A Flanged
		A Threaded
3"R	DN80R	G Threaded

Size	Pattern	Connection
3"R	DN80R	G Flanged
		A Threaded
3"	DN80	G Threaded
		G Flanged
		G Grooved
		A Threaded
4"	DN100	A Flanged
		A Threaded
6"	DN150	G Flanged



Solenoid Controlled Valve

with 3-Way Control, Metal Accessories (R)

IR-410-RX

Solenoid S-390-3W; S-400

Size	Pattern	Connection
1"	DN25	G Threaded
1½"	DN40	G Threaded
2"	DN50	G Threaded
		G Flanged
		G Grooved
		A Threaded
2½"	DN65	A Flanged
		A Threaded
3"R	DN80R	G Threaded
		G Flanged
3"	DN80	A Threaded
		G Threaded
		G Flanged

Size	Pattern	Connection
3"	DN80	G Grooved
		A Threaded
4"	DN100	G Flanged
		A Grooved
6"	DN150	G Flanged
		A Grooved
8"	DN200	G Flanged
		A Grooved
10"	DN250	G Flanged
12"	DN300	G Flanged
14"	DN350	G Flanged
16"	DN400	G Flanged





Pressure Reducing Valve

with 3-Way Control, Manual Selector, Metal Accessories (R)

IR-420-RXZ

Size	Pattern	Connection
1½"	DN40	G Threaded
2"	DN50	G Threaded
		G Flanged
		G Grooved
		A Threaded
2½"	DN65	A Flanged
		A Threaded
3"R	DN80R	G Threaded
		G Flanged
3"	DN80	A Threaded
		A Flanged

Size	Pattern	Connection
3"	DN80	G Grooved
		A Threaded
4"	DN100	A Flanged
		G Flanged
		G Grooved
6"	DN150	A Flanged
		G Flanged
8"	DN200	G Grooved
		G Flanged
10"	DN250	G Flanged
12"	DN300	G Flanged
14"	DN350	G Flanged
16"	DN400	G Flanged



Pressure Reducing Valve

with 3-Way Control, Manual Selector, Plastic Pilot and Accessories (K)

IR-420-KXZ

Size	Pattern	Connection
1½"	DN40	G Threaded
2"	DN50	G Threaded
		G Flanged
		G Grooved
		A Threaded
2½"	DN65	A Flanged
		A Threaded
3"R	DN80R	G Threaded
		G Flanged

Size	Pattern	Connection
3"R	DN80R	A Threaded
3"	DN80	A Threaded
		G Flanged
4"	DN100	G Grooved
		A Threaded
		A Flanged
6"	DN150	G Flanged
		G Grooved



Pressure Reducing Valve

with 2-Way Control, Hydraulic Control, Metal Pilot and Accessories (R)

IR-420-50-2W-R

Size	Pattern	Connection
1½"	DN40	G Threaded
2"	DN50	G Threaded
		G Flanged
		G Grooved
		A Threaded
2½"	DN65	A Flanged
		A Threaded
3"R	DN80R	G Threaded
		G Flanged
3"	DN80	A Threaded
		A Flanged

Size	Pattern	Connection
3"	DN80	G Grooved
		A Threaded
4"	DN100	A Flanged
		G Flanged
		G Grooved
6"	DN150	A Flanged
		G Flanged
8"	DN200	G Grooved
		G Flanged
10"	DN250	G Flanged
12"	DN300	G Flanged
14"	DN350	G Flanged
16"	DN400	G Flanged





Pressure Reducing Valve

with 3-Way Control, Hydraulic Control with Manual Selector, Metal Pilot and Accessories (R)

IR-420-50-RXZ

Size	Pattern	Connection	Size	Pattern	Connection
1½"	DN40	G Threaded	3"	DN80	G Grooved
2"	DN50	G Threaded			A Threaded
		G Flanged	A Flanged		
		G Grooved	G Flanged		
		A Threaded	A Grooved		
2½"	DN65	A Flanged	4"	DN100	G Flanged
		G Threaded			A Flanged
3"	DN80R	A Threaded	6"	DN150	G Flanged
		G Flanged			G Grooved
3"	DN80	A Threaded	8"	DN200	G Flanged
		G Flanged			G Grooved
3"	DN80	A Threaded	10"	DN250	G Flanged
		G Flanged			G Flanged
3"	DN80	A Threaded	12"	DN300	G Flanged
		G Flanged			G Flanged
3"	DN80	A Threaded	14"	DN350	G Flanged
		G Flanged			G Flanged
3"	DN80	A Threaded	16"	DN400	G Flanged
		G Flanged			G Flanged



Pressure Reducing Valve

with 3-Way Control, Hydraulic Control, Manual Selector, Plastic Pilot and Accessories (K)

IR-420-50-KXZ

Size	Pattern	Connection	Size	Pattern	Connection
1½"	DN40	G Threaded	3"	DN80R	A Threaded
2"	DN50	G Threaded			G Threaded
		G Flanged	G Flanged		
		G Grooved	G Grooved		
		A Threaded	A Threaded		
2½"	DN65	A Flanged	4"	DN100	G Flanged
		G Threaded			G Grooved
3"	DN80R	G Threaded	6"	DN150	A Flanged
		G Flanged			G Flanged



Pressure Reducing Valve

with 3-Way Control, Hydraulic Relay, Plastic Pilot and Accessories (K)

IR-420-54-KX

Size	Pattern	Connection	Size	Pattern	Connection
1½"	DN40	G Threaded	3"	DN80R	A Threaded
2"	DN50	G Threaded			G Threaded
		G Flanged	G Flanged		
		G Grooved	G Grooved		
		A Threaded	A Threaded		
2½"	DN65	A Flanged	4"	DN100	G Flanged
		G Threaded			G Grooved
3"	DN80R	G Threaded	6"	DN150	A Flanged
		G Flanged			G Flanged





Pressure Reducing Valve

with 2-Way Control, Electric Control, Metal Pilot and Accessories (R)

IR-420-55-R

Solenoid 2W

Size	Pattern	Connection
1½"	DN40	G Threaded
2"	DN50	G Threaded
		G Flanged
		G Grooved
		A Threaded
2½"	DN65	A Flanged
		A Threaded
3"R	DN80R	G Threaded
		G Flanged
3"	DN80	A Threaded
		A Flanged

Size	Pattern	Connection
3"	DN80	G Grooved
		A Threaded
4"	DN100	A Flanged
		G Grooved
6"	DN150	G Flanged
		G Grooved
8"	DN200	G Flanged
		G Grooved
10"	DN250	G Flanged
12"	DN300	G Flanged
14"	DN350	G Flanged
16"	DN400	G Flanged



Pressure Reducing Valve

with 3-Way Control, Electric Control, Plastic Pilot and Accessories (K)

IR-420-55-KX

Solenoid S-390-3W; S-400

Size	Pattern	Connection
1½"	DN40	G Threaded
2"	DN50	G Threaded
		G Flanged
		G Grooved
		A Threaded
2½"	DN65	A Flanged
		A Threaded
3"R	DN80R	G Threaded
		G Flanged

Size	Pattern	Connection
3"R	DN80R	A Threaded
3"	DN80	G Threaded
		A Flanged
4"	DN100	G Grooved
		A Flanged
6"	DN150	G Flanged
		G Grooved



Pressure Reducing & Sustaining Valve

with 3-Way Control, Manual Selector, Metal Pilot and Accessories (R)

IR-423-RXZ

Size	Pattern	Connection
1½"	DN40	G Threaded
2"	DN50	G Threaded
		G Flanged
		G Grooved
		A Threaded
2½"	DN65	A Flanged
		A Threaded
3"R	DN80R	G Threaded
		G Flanged
3"	DN80	A Threaded
		A Flanged

Size	Pattern	Connection
3"	DN80	G Grooved
		A Threaded
4"	DN100	A Flanged
		G Grooved
6"	DN150	G Flanged
		G Grooved
8"	DN200	G Flanged
		G Grooved
10"	DN250	G Flanged
12"	DN300	G Flanged
14"	DN350	G Flanged
16"	DN400	G Flanged



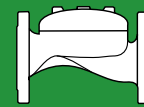

Pressure Reducing & Sustaining Valve

with 3-Way Control, Manual Selector, Plastic Pilot and Accessories (K)

IR-423-KXZ

Size	Pattern	Connection
1½"	DN40	G Threaded
2"	DN50	G Threaded
		G Flanged
		G Grooved
		A Threaded
2½"	DN65	A Flanged
		G Threaded
3"R	DN80R	A Threaded
		G Threaded
3"	DN80	A Flanged
		G Threaded

Size	Pattern	Connection
3"R	DN80R	A Threaded
3"	DN80	G Threaded
		G Flanged
		G Grooved
		A Threaded
4"	DN100	A Flanged
		G Threaded
6"	DN150	A Grooved
		G Flanged



Pressure Sustaining Valve

with 3-Way Control, Metal Pilot and Accessories (R)

IR-430-RX

Size	Pattern	Connection
1½"	DN40	G Threaded
2"	DN50	G Threaded
		G Grooved
		G Flanged
		A Threaded
2½"	DN65	A Flanged
		G Threaded
3"R	DN80R	A Flanged
		G Threaded
3"	DN80	A Threaded
		G Grooved

Size	Pattern	Connection
3"	DN80	G Flanged
		A Threaded
4"	DN100	A Flanged
		G Grooved
6"	DN150	A Flanged
		G Grooved
8"	DN200	A Flanged
		G Grooved
10"	DN250	G Flanged
12"	DN300	G Flanged
14"	DN350	G Flanged
16"	DN400	G Flanged



Pressure Sustaining Valve

with 3-Way Control, Manual Selector, Plastic Pilot and Accessories (K)

IR-430-KXZ

Size	Pattern	Connection
1½"	DN40	G Threaded
2"	DN50	G Threaded
		G Flanged
		G Grooved
		A Threaded
2½"	DN65	A Flanged
		G Threaded
3"R	DN80R	A Threaded
		G Threaded
3"	DN80	A Flanged
		G Threaded

Size	Pattern	Connection
3"R	DN80R	A Threaded
3"	DN80	G Threaded
		G Flanged
		G Grooved
		A Threaded
4"	DN100	A Flanged
		G Flanged
6"	DN150	A Grooved
		G Flanged





Pressure Sustaining Valve

with Electric Control 3-Way, Metal Pilot and Accessories (R)

IR-430-55-RX

Solenoid 3W

Size	Pattern	Connection
1½"	DN40	G Threaded
2"	DN50	G Threaded
		G Grooved
		G Flanged
	A	G Threaded
		G Flanged
2½"	DN65	G Threaded
		A Threaded
3"R	DN80R	G Threaded
		A Threaded
3"	DN80	G Threaded
		G Grooved

Size	Pattern	Connection
3"	DN80	G Flanged
		A Threaded
4"	DN100	A Flanged
		G Grooved
6"	DN150	G Flanged
		A Grooved
8"	DN200	G Flanged
		A Grooved
10"	DN250	G Flanged
12"	DN300	G Flanged
14"	DN350	G Flanged
16"	DN400	G Flanged



Pressure Sustaining Valve

with Electric Control 3-Way, Plastic Pilot and Accessories (K)

IR-430-55-KX

Solenoid S-390-3W; S-400

Size	Pattern	Connection
1½"	DN40	G Threaded
2"	DN50	G Threaded
		G Flanged
		G Grooved
	A	G Threaded
		G Flanged
2½"	DN65	G Threaded
		A Threaded
3"R	DN80R	G Threaded
		G Flanged

Size	Pattern	Connection
3"R	DN80R	A Threaded
3"	DN80	G Threaded
		A Flanged
4"	DN100	G Grooved
		A Flanged
6"	DN150	G Flanged
		A Flanged



Quick Pressure Relief Valve

with Metal Pilot and Accessories (R)

IR-43Q-R

Size	Pattern	Connection
1½"	DN40	G Threaded
2"	DN50	G Threaded
		G Grooved
		G Flanged
	A	G Threaded
		G Flanged
2½"	DN65	G Threaded
		A Threaded
3"R	DN80R	G Threaded
		A Threaded
3"	DN80	G Threaded
		G Grooved

Size	Pattern	Connection
3"	DN80	G Flanged
		A Threaded
4"	DN100	A Flanged
		G Grooved
6"	DN150	G Flanged
		A Grooved
8"	DN200	G Flanged
		A Grooved
10"	DN250	G Flanged
12"	DN300	G Flanged
14"	DN350	G Flanged
16"	DN400	G Flanged





Quick Pressure Relief Valve

with Plastic Pilot and Accessories (K)

IR-43Q-K

Size	Pattern	Connection
1½"	DN40	G Threaded
2"	DN50	G Threaded
		G Flanged
		G Grooved
		A Threaded
2½"	DN65	A Flanged
		G Threaded
3"R	DN80R	A Flanged
		G Threaded

Size	Pattern	Connection
3"R	DN80R	A Threaded
3"	DN80	G Threaded
		G Flanged
		G Grooved
		A Threaded
4"	DN100	A Flanged
		G Flanged
6"	DN150	G Grooved
		A Flanged



Level Control Valve

with 2-Way Control, Horizontal Float, Metal Pilot and Accessories (R)

IR-450-60-R

Size	Pattern	Connection
1½"	DN40	G Threaded
2"	DN50	G Threaded
		G Grooved
		G Flanged
		A Threaded
2½"	DN65	A Flanged
		G Threaded
3"R	DN80R	A Flanged
		G Threaded
3"	DN80	G Threaded
		G Grooved

Size	Pattern	Connection
3"	DN80	G Flanged
		A Threaded
4"	DN100	A Flanged
		G Grooved
6"	DN150	A Flanged
		G Grooved
8"	DN200	A Flanged
		G Grooved
10"	DN250	G Flanged
12"	DN300	G Flanged
14"	DN350	G Flanged
16"	DN400	G Flanged



Level Control Valve

with 2-Way Control, Horizontal Float, Plastic Pilot and Accessories (K)

IR-450-60-K

Size	Pattern	Connection
1½"	DN40	G Threaded
2"	DN50	G Threaded
		G Flanged
		G Grooved
		A Threaded
2½"	DN65	A Flanged
		G Threaded
3"R	DN80R	A Flanged
		G Threaded

Size	Pattern	Connection
3"R	DN80R	A Threaded
3"	DN80	G Threaded
		G Flanged
		G Grooved
		A Threaded
4"	DN100	A Flanged
		G Flanged
6"	DN150	G Grooved
		A Flanged





Level Control Valve, 3-Way with Bi Level Vertical Float,

Manual Selector, Metal Pilot and Accessories (R)

IR-450-66-RZ

Size	Pattern	Connection
1½"	DN40	G Threaded
2"	DN50	G Threaded
		G Grooved
		G Flanged
		A Threaded
2½"	DN65	A Flanged
		G Threaded
3"R	DN80R	G Flanged
		A Threaded
3"	DN80	G Threaded
		G Grooved

Size	Pattern	Connection
3"	DN80	G Flanged
		A Threaded
		A Flanged
4"	DN100	G Grooved
		G Flanged
6"	DN150	A Flanged
		G Grooved
8"	DN200	G Flanged
		G Grooved
10"	DN250	G Flanged
12"	DN300	G Flanged
14"	DN350	G Flanged
16"	DN400	G Flanged



Flow Control Valve

with 2/3-Way Control, Manual Selector, Metal Pilot and Accessories (R)

IR-470-bRUZ

Size	Pattern	Connection
1½"	DN40	G Threaded
2"	DN50	G Threaded
		G Grooved
		G Flanged
		A Threaded
2½"	DN65	A Flanged
		G Threaded
3"R	DN80R	G Flanged
		A Threaded
3"	DN80	G Threaded
		G Grooved

Size	Pattern	Connection
3"	DN80	G Flanged
		A Threaded
4"	DN100	A Flanged
		G Grooved
6"	DN150	G Flanged
		A Flanged
8"	DN200	G Grooved
		G Flanged
10"	DN250	G Flanged
12"	DN300	G Flanged
14"	DN350	G Flanged
16"	DN400	G Flanged



Flow Control Valve

with 2/3-Way Control, Plastic Pilot and Accessories (K)

IR-470-bKeU

Size	Pattern	Connection
1½"	DN40	G Threaded
2"	DN50	G Threaded
		G Flanged
		G Grooved
		A Threaded
2½"	DN65	A Flanged
		G Threaded
3"R	DN80R	G Flanged
		A Threaded

Size	Pattern	Connection
3"R	DN80R	A Threaded
3"	DN80	G Threaded
		G Flanged
4"	DN100	G Grooved
		A Threaded
6"	DN150	A Flanged
		G Flanged





Additional Features & Options - Suffix Code-K (Plastic Accessories)

Code	Description
20-3W-P	Check Feature (Shuttle Valve) - Plastic
50-3W-P	Hydraulic Control (Shuttle Valve) - Plastic
50-2W-P	Hydraulic Control (2-Way Hydraulic Relay) - Plastic
54-3W-P	½" 3-Way Hydraulic Relay (3W-HRV) - Plastic
55	Solenoid Controlled
F	Large Control Filter
I	Position Indicator Assembly
M	Flow Stem
Z	Manual Selector
5	Plastic Test Point

Additional feature prices are available.

Additional Features & Options - Suffix Code - R (Metal Accessories)

Code	Description
20-2W-M	Check Feature - 1½"-16"
20-3W-M	Check Feature (Shuttle Valve) - 1½"-4"
20-3W-M	Check Feature (Shuttle Valve) - 6"-16"
50-2W-M	¾" 2-Way Hydraulic Relay (2W-HRV) - Brass
50-3W-M	Hydraulic Control (Shuttle Valve) - 1½"-4"
50-3W-M	Hydraulic Control (Shuttle Valve) - 6"-16"
54-3W-M	Hydraulic Accelerator Control - 1½"-10"
54-3W-M	Hydraulic Accelerator Control - 12"-16"
55	Solenoid Controlled - 1½"-4"
55	Solenoid Controlled - 6"-16"
F	Large Control Filter - 1½"-16"
I	Position Indicator Assembly - 1½"-4"
I	Position Indicator Assembly - 6"-8"
I	Position Indicator Assembly - 10"-16"
M	Flow Stem - 1½"-4"
M	Flow Stem - 6"-8"
M	Flow Stem - 10"-16"
Z	Manual Selector - 1½"-4"
Z	Manual Selector - 6"-16"
5	Plastic Test Point

Additional feature prices are available.

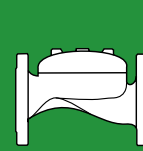

Packing Specifications

1"

1½", 2"

3"

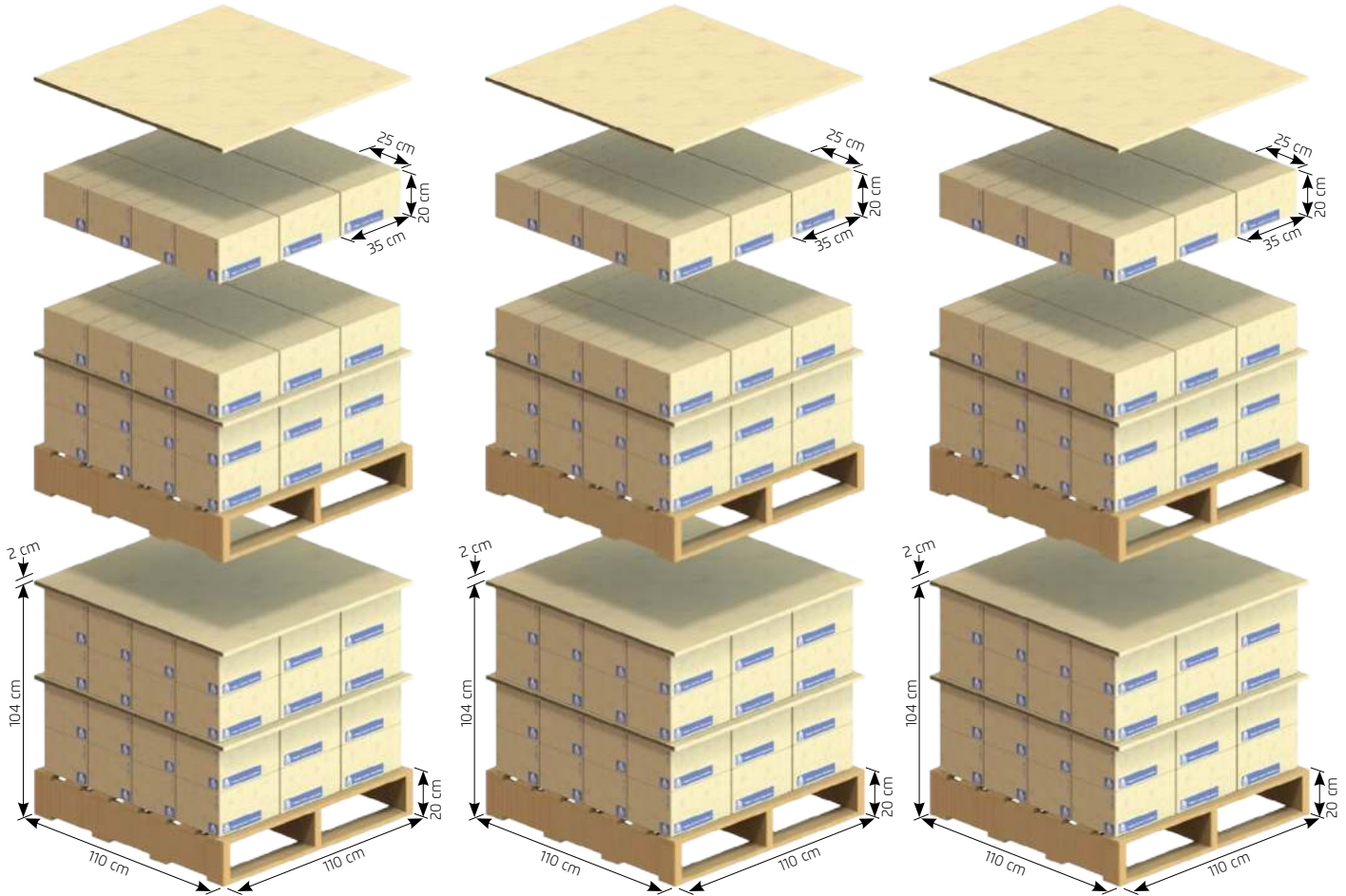

Per Box

Valve Size	Box					
	Units	Length [cm]	Width [cm]	Height [cm]	Weight [kg]	Volume [m³]
1"	6	35	25	20	6.2	0.02
1 ½"	4	35	25	20	8.3	0.02
2"	4	35	25	20	16.3	0.02
3" Threaded	1	35	25	20	13.3	0.02
3" Flange	1	35	25	20	19.3	0.02

Per Pallet

Valve Size	Pallet							
	Number of Boxes	Number of Levels	Number of Units	Length [cm]	Width [cm]	Height [cm]	Gross Weight [kg]	Volume [m³]
1"	48	4	288	110	110	104	318	1.3
1 ½"	48	4	192	110	110	104	419	1.3
2"	48	4	192	110	110	104	802	1.3
3" Threaded	48	4	48	110	110	104	658	1.3
3" Flange	48	4	48	110	110	104	946	1.3



Packing Specifications

4"

6"

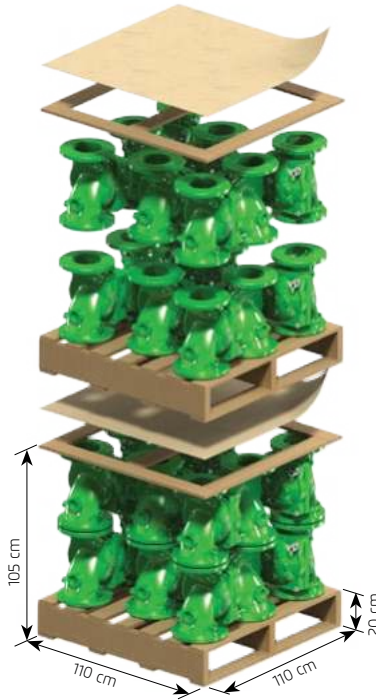

4"	
No. of Layers	2
No. of Units	24
Length [cm]	110
Width [cm]	110
Height [cm]	86
Gross Weight	692
Volume [m ³]	1.04

6"	
No. of Layers	2
No. of Units	16
Length [cm]	110
Width [cm]	110
Height [cm]	105
Gross Weight	1108
Volume [m ³]	1.27

8"

10"

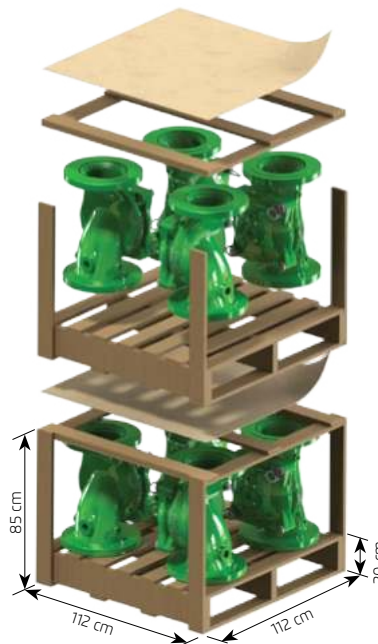
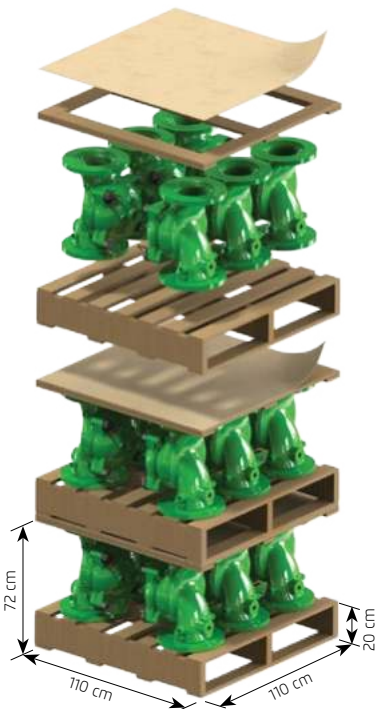

8"	
No. of Layers	1
No. of Units	6
Length [cm]	110
Width [cm]	110
Height [cm]	72
Gross Weight	770
Volume [m ³]	1.31

10"	
No. of Layers	1
No. of Units	4
Length [cm]	112
Width [cm]	112
Height [cm]	85
Gross Weight	580
Volume [m ³]	1.07

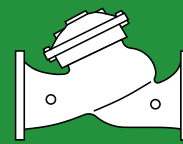

IR-700 SIGMA Series

BERMAD IR-700-SIGMA-ES and IR-700-SIGMA-EN Series Valves are hydraulically operated globe valves in standard oblique "Y" pattern with full bore (IR-700-SIGMA-EN only) hydrodynamic body providing an unobstructed flow path, with raised seat assembly and double chamber unitized actuator that can be disassembled from the body as a separate integral unit.

The IR-700-SIGMA-ES and SIGMA-EN valves have an excellent and highly effective modulation capacity for high differential pressure applications, and are designed to operate with minimal cavitation and noise under difficult operation conditions. Both IR-700-SIGMA-ES and SIGMA-EN series valves are meeting the ISO face to face standard requirements.

IR-700-SIGMA-EN Series range in diameter sizes from 1½"-16" and IR-700-SIGMA-ES range in diameter sizes from 2½"-24".

Features and Benefits

- Line pressure driven – Independent operation
- In-line serviceable – Easy maintenance
- Double chamber design
 - Moderated valve reaction
 - Protected diaphragm
- Flexible design – Easy addition of features
- Variety of accessories – Perfect mission matching
- "Y" or angle, wide body – Minimized pressure loss
- Semi-straight flow – Non-turbulent flow
- Stainless Steel raised seat – Cavitation damage resistant
- Obstacle free, full bore – Uncompromising reliability
- V-Port Throttling Plug – Low flow stability

Typical Applications

- Extreme high or low pressure, flow, water quality and pressure differential conditions.
- Where required pressure rating exceeds PN16
- When required diameters are above 16" and up to 48"
- Application require double chamber actuator:
 - Pump control active check valve
 - Proportional "Pilotless" pressure reducing valves
 - Power opening and closing level control valves
 - Safe "close and lock" burst control valves

BERMAD Irrigation

High Performance Double Chambered Control Valves 1½" - 48"

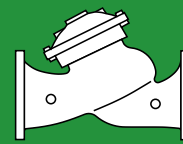

[1] Double-Chambered Actuator

- Actuator assembly can be removed as one integral unit
- Simple on-site conversion to single-chambered

[2] Diaphragm Assembly

The flexible, unshaped, nylon-reinforced diaphragm is supported over the majority of its surface.

[3] Cover Plug

Enables on-site retrofit of: Indicator [3A]; Limit Switch; Position Transmitter.

[4] Inherent Separation Partition

The inherent separation includes the bearing [5A], which provides complete central guiding for the valve moving assembly. The separation partition separates the lower control chamber from the flow in both the single-chambered, and the double-chambered configurations.

[5] Spring

Required for single-chambered configurations.

[6] Seal Disc Assembly

Self-aligning, seal disc assembly provides balanced, free movement and a resilient seal for perfect, drip-tight sealing. It enables using several variations of seals and plugs.

[7] Seat

Stainless steel, raised, replaceable in-line and on-site.

[8] Wide Body ("Y" or Angle Pattern)

Hydro-dynamically designed for efficient flow with minimal pressure loss and excellent resistance to cavitation. Full bore, valve port area clear of obstructions; no ribs or stem guides. Increases capacity by 25% over standard globe valves.

[9] End Connections

Conforms to pressure ratings and standards of: ISO, ANSI, AS, JIS, and others.

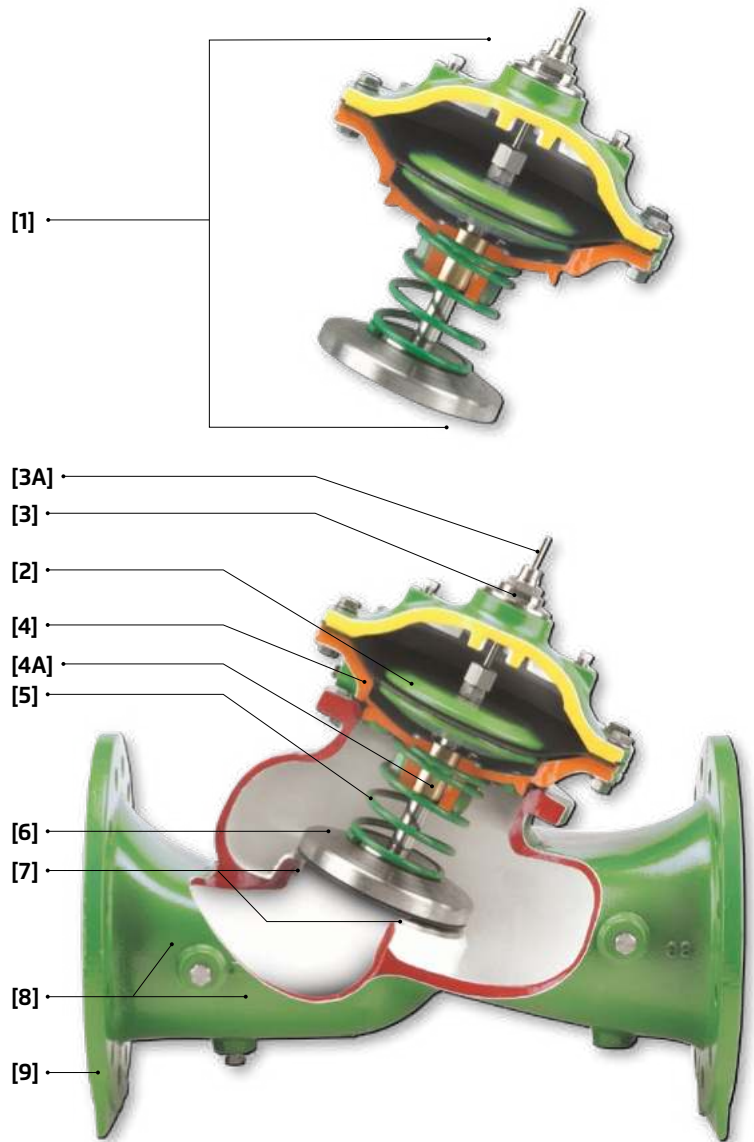

Valve Plug Options

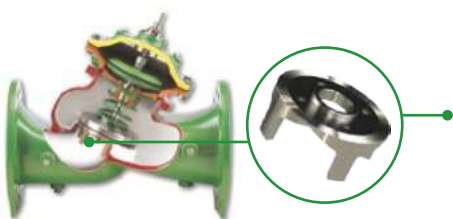

Flat Disc

"Quick opening plug": Standard plug provides high flow and quick response.

Throttling Plug

A throttling plug is used in order to provide more accurate, stable and smooth response for pressure and flow regulation while reducing noise and vibration.

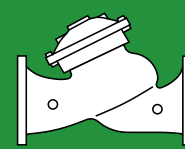

700-SIGMA-ES Series

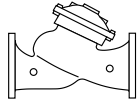

Available Sizes & Patterns

- DN65 - DN600; 2½" - 24" - Y Pattern

Pressure Rating

- PN 10, 16 & 25 (According to Connection Rating)

Connection Standard

- Flanged:
 - SO 7005-2 (ISO 10, 16 & 25)
 - ASME B165 CLASS 150 & 300
 - JIS B2210 10K, 16K
 - BS10 BSTD & BSTH
 - ABNT NBR 7675 PN10, 16 & 25
 - AS 4087 PN16 & 35

Standard Materials

- Main valve body& cover: Ductile Iron to EN 1563 or ASTM A-536
- Main valve internals: Steel, Bronze & Epoxy coated Steel
- Control trim: Brass, Bronze accessories
- Brass fittings & Reinforced Plastic tubing
- Elastomers: Synthetic Rubber
- Coating: Green fusion bonded Polyester

700-SIGMA-EN Series

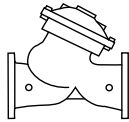

Available Sizes & Patterns

- DN50 - DN300; 1½"-16" - Y Pattern

Pressure Rating

- PN 10, 16 & 25 (According to Connection Rating)

Connection Standard

- Flanged:
 - ISO 7005-2 (ISO 10, 16 & 25)
 - ASME B165 CLASS 150 & 300
 - JIS B2210 10K, 16K
 - BS10 BSTD & BSTH
 - ABNT NBR 7675 PN10, 16 & 25
 - AS 4087 PN16 & 35

Standard Materials

- Main valve body& cover: Ductile Iron to EN 1563 or ASTM A-536
- Main valve internals: Steel, Bronze & Epoxy coated Steel
- Control trim: Brass, Bronze accessories
- Brass fittings & Reinforced Plastic tubing
- Elastomers: Synthetic Rubber
- Coating: Green fusion bonded Polyester

700; M5; M6 & M5L Series

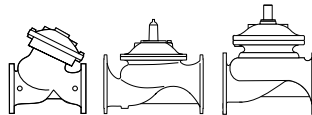

Available Sizes & Patterns

- DN40 - DN500; 1½" - 20" - Y PATTERN
- DN40 - DN450; 1½" - 18" - Angle
- DN600 - DN900; 24" - 48" - Globe

Pressure Rating

- PN 10, 16 & 25 (According to Connection Rating)

Connection Standard

- Threaded: BSP (Rp ISO 7/1) or NPT (DN40 - DN80; 1½" - 3")
- Flanged:
 - ISO 7005-2 (ISO 10, 16 & 25)
 - ASME B165 CLASS 150 & 300
 - JIS B2210 10K, 16K
 - BS10 BSTD & BSTH
 - ABNT NBR 7675 PN10, 16 & 25
 - AS 4087 PN16 & 35

Standard Materials

- Main valve body& cover: Ductile Iron to EN 1563 or ASTM A-536
- Main valve internals: Steel, Bronze & Epoxy coated Steel
- Control trim: Brass, Bronze accessories
- Brass fittings & Reinforced Plastic tubing
- Elastomers: Synthetic Rubber
- Coating: Green fusion bonded Polyester

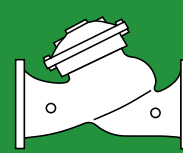

Flow Charts

700-Sigma-ES

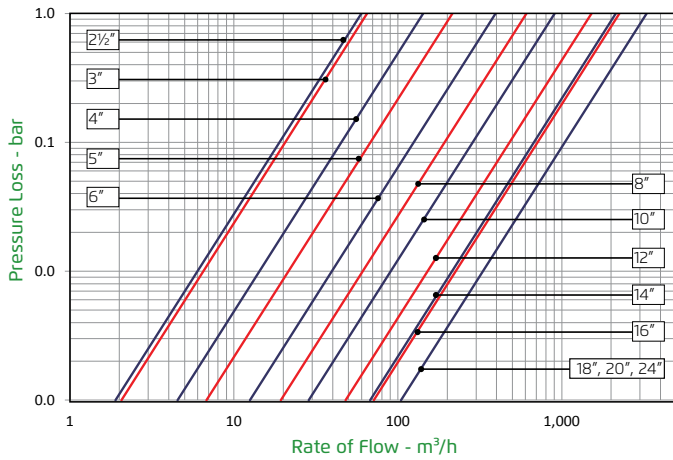

700-Sigma-EN; 700; -M5; -M6; -M5L

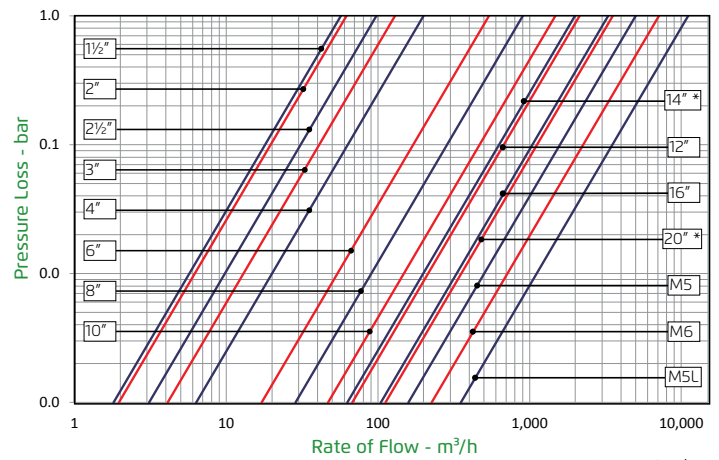

* 700 Series

Flow Properties

700-SIGMA-ES		DN	65	80	100	125	150	200	250	300	400	500	600
		inch	2½"	3"	4"	5"	6"	8"	10"	12"	16"	20"	24"
Y-Pattern Flat Disc	Kv		60	65	145	215	395	610	905	1,520	2,250	4,070	4,275
	Cv		69	75	168	248	456	705	1,046	1,756	2,600	4,703	4,938
Y-Pattern U-Plug	Kv		51	55	123	183	336	519	769	1,292	2,027	3,460	3,634
	Cv		59	64	142	211	388	599	888	1,492	2,341	3,996	4,197

700-SIGMA-EN		DN	40	50	65	80	100	150	200	250	300	400
		inch	1½"	2"	2½"	3"	4"	6"	8"	10"	12"	16"
Y-Pattern Flat Disc	Kv		57	62	98	130	200	540	905	1,480	2,140	3,330
	Cv		66	72	113	150	231	624	1,045	1,709	2,472	3,812
Y-Pattern U-Plug	Kv		46	48	73	102	140	453	767	1,310	1,940	2,970
	Cv		53	55	84	118	162	523	886	1,513	2,241	3,430

700		mm	40	50	65	80	100	150	200	250	300	350	400	450	500
		inch	1½"	2"	2½"	3"	4"	6"	8"	10"	12"	14"	16"	18"	20"
Y-Pattern Flat Disc	Kv		42	50	55	115	200	460	815	1,250	1,850	1,990	3,310	3,430	3,550
	Cv		49	58	64	133	230	530	940	1,440	2,140	2,300	3,820	3,960	4,100
Y-Pattern V-Port	Kv		36	43	47	98	170	391	693	1,063	1,573	1,692	2,814	2,916	3,018
	Cv		41	49	54	113	200	450	800	1,230	1,820	1,950	3,250	3,370	3,490
Angle Flat Disc	Kv		46	55	61	127	220	506	897	1,375	2,035	2,189	3,641	3,773	NA
	Cv		53	64	70	146	250	580	1,040	1,590	2,350	2,530	4,210	4,360	NA
Angle V-Port	Kv		39	47	51	108	187	430	762	1,169	1,730	1,861	3,095	3,207	NA
	Cv		45	54	59	124	220	500	880	1,350	2,000	2,150	3,580	3,710	NA

700-M5; 700-M6; 700-M5L

		M5	M6	M5L
G-Pattern Flat Disc	Kv	5,020	7,150	11,150
	Cv	5,798	8,258	12,878

Differential Pressure & Flow Calculation

$$\Delta P = \left(\frac{Q}{Kv} \right)^2$$

Kv = m³/h @ ΔP of 1 bar

Q = m³/h

ΔP = bar

$$Cv = 1.155 Kv$$

Where:

Kv = Valve flow coefficient (flow in m³/h at 1bar Diff. Press.)

Cv = Valve flow coefficient (flow in gpm at 1psi Diff. Press.)

Q = Flow rate (m³/h; gpm)

ΔP = Differential pressure (bar; psi)

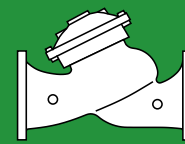

Flanged

700-SIGMA-ES Series

Y Pattern	DN	65	80	100	125	150	200	250	300	400	500	600	
	inch	2½"	3"	4"	5"	6"	8"	10"	12"	16"	20"	24"	
	ISO PN 10; 16; 25	L* (mm)	290	310	350	400	480	600	730	850	1,100	1,250	1,450
	W (mm)	185	200	235	270	300	360	425	530	626	838	845	
	h (mm)	98	108	130	140	163	193	227	265	334	398	490	
	H (mm)	242	252	318	375	411	506	600	721	943	1,220	1,240	
	Weight (Kg)	18	22	38	62	78	125	198	306	515	1,085	1,290	

* Maximum Dimensions (Length according to EN 558-1; ISO 5752)

700-SIGMA-EN Series

Y Pattern	DN	40	50	65	80	100	150	200	250	300	400	
	inch	1½"	2"	2½"	3"	4"	6"	8"	10"	12"	16"	
	ISO PN 10; 16; 25	L* (mm)	230	230	290	310	350	480	600	730	850	1,100
	W (mm)	155	165	180	210	255	320	400	480	570	815	
	h (mm)	81	86	92	108	130	163	193	227	272	334	
	H (mm)	234	246	290	252	318	514	618	725	881	1,171	
	Weight (Kg)	12	14	20	28	47	96	158	256	403	974	

* Maximum Dimensions (Length according to EN 558-1; ISO 5752)

700 Series - M5, M6 & M5L

G Pattern	Type	DN	500	600	700	750	800	900	1000	1050	1200	
		inch	20"	24"	28"	30"	32"	36"	40"	42"	48"	
	M5	PN 16; 25	L (mm)**	1,250	1,450	1,460	1,750	1,850 1,865 ⁽¹⁾	-	-	-	-
			W (mm)	965	965	965	1,020	1,026 1,106 ⁽¹⁾	-	-	-	-
			h (mm)	385	435	493	530	530	-	-	-	-
			H (mm)	1,235	1,350	1,410	1,380	1,448	-	-	-	-
			Weight (kg)	1,318	1,590	1,745	1,711	1,920	-	-	-	-
	M6	PN 16; 25	L (mm)**	-	1,450 1,500 ⁽¹⁾	1,650	1,8750	1,850	1,850	-	-	-
			W (mm)	-	1,250	1,250	1,250	1,250	1,250	-	-	-
			h (mm)	-	470	490	520	552	600	-	-	-
			H (mm)	-	1,965	1,985	2,015	1,760	1,810	-	-	-
			Weight (kg)	-	3,250	3,700	3,900	4,100	4,250	-	-	-
	M5L	PN 16; 25	L (mm)**	-	-	-	1,750	1,850	2,050	2,250	2,251	2,252
			W (mm)	-	-	-	1,425	1,425	1,425	1,425	1,345	1,530
			h (mm)	-	-	-	507	545	600	660	693	785
			H (mm)	-	-	-	1,740	1,780	1,835	1,900	1,913	2,001
			Weight (kg)	-	-	-	3,300	3,200	3,350	3,710	4,216	4,062

* Maximum Dimensions (Length according to EN 558-1; ISO 5752)

** Length may vary according to flange standard.

⁽¹⁾ PN25

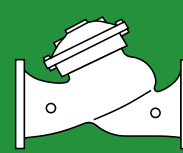

700 Series

Angle Pattern		DN	40	50	65	80	100	150	200	250	300	350	400	450
		inch	1 1/2"	2"	2 1/2"	3"	4"	6"	8"	10"	12"	14"	16"	18"
	PN 10; 16	L	124	124	149	152	190	225	265	320	396	400	450	450
		W	155	155	178	200	222	320	390	480	550	550	740	740
		R	78	83	95	100	115	143	172	204	248	264	299	320
		h	85	85	109	102	127	152	203	219	273	279	369	370
		H	227	227	251	281	342	441	545	633	777	781	1,082	1,082
	Weight (Kg)	9.5	10	12	21.5	35	71	118	205	350	370	800	820	
	PN 25	L	124	124	149	159	200	234	277	336	415	419	467	467
		W	165	165	185	207	250	320	390	480	550	550	740	740
		R	78	85	95	105	127	159	191	223	261	293	325	358
		h	85	85	109	109	135	165	216	236	294	299	386	386
H		227	227	251	287	350	454	558	649	796	801	1,099	1,099	
Weight (Kg)	11	11.5	13.5	23	41	81	138	233	390	425	855	870		

Y Pattern		DN	40	50	65	80	100	150	200	250	300	350	400	450	500
		inch	1 1/2"	2"	2 1/2"	3"	4"	6"	8"	10"	12"	14"	16"	18"	20"
	PN 10; 16	L*	205	210	222	250	320	415	500	605	725	733	990	1,000	1,100
		W	155	165	178	200	223	320	390	480	550	550	740	740	740
		h	78	83	95	100	115	143	172	204	242	268	300	319	358
		H	239	244	257	305	366	492	584	724	840	866	1,108	1,127	1,167
		Weight (Kg)	9.1	10.6	13	22	37	75	125	217	370	381	846	945	962
	PN 25	L	205	210	222	264	335	433	524	637	762	767	1,024	1,030	1,136
		W	155	165	185	207	250	320	390	480	550	570	740	740	750
		h	78	83	95	105	127	159	191	223	261	295	325	357	389
		H	239	244	257	314	378	508	602	742	859	893	1,133	1,165	1,197
		Weight (Kg)	10	12.2	15	25	43	85	146	245	410	434	900	967	986

Threaded

Angle Pattern		DN	50	65	80
		inch	2"	2 1/2"	3"
	BSP; NPT	L	121	140	159
		W	122	122	163
		R	40	48	55
		h	83	102	115
		H	225	242	294
	Weight (Kg)	5.5	7	15	

Y Pattern		DN	40	50	65	80
		inch	1 1/2"	2"	2 1/2"	3"
	BSP; NPT	L	155	155	212	250
		W	122	122	122	163
		h	40	40	48	56
		H	201	202	209	264
		Weight (Kg)	5.5	5.5	8	17

Control Chamber Displacement Volume (liter)

DN	40	50	65	80	100	125	150	200	250	300	350	400	450	500	600 - 1200
inch	1 1/2"	2"	2 1/2"	3"	4"	5"	6"	8"	10"	12"	14"	16"	18"	20"	21"- 48"
700-ES Sigma Series	-	-	0.125	0.125	0.3	0.45	0.5	2.15	4.5	8.5	-	12.4	-	29.8	29.8
700-EN Sigma Series	-	0.125	-	0.3	0.45	-	2.15	4.5	8.5	12.4	-	29.8	-	-	-
700 Series	0.125	0.125	0.125	0.3	0.45	-	2.15	4.5	8.5	12.4	12.4	29.8	29.8	29.8	98
800 Series	0.04	0.04	0.04	0.12	0.3	-	1.1	2.3	4.0	8.0	8.0	18.7	18.7	18.7	-
700-M5 Series	-	-	-	-	-	-	-	-	-	-	-	-	-	-	60
700-M6 Series	-	-	-	-	-	-	-	-	-	-	-	-	-	-	98
700-M5L Series	-	-	-	-	-	-	-	-	-	-	-	-	-	-	230

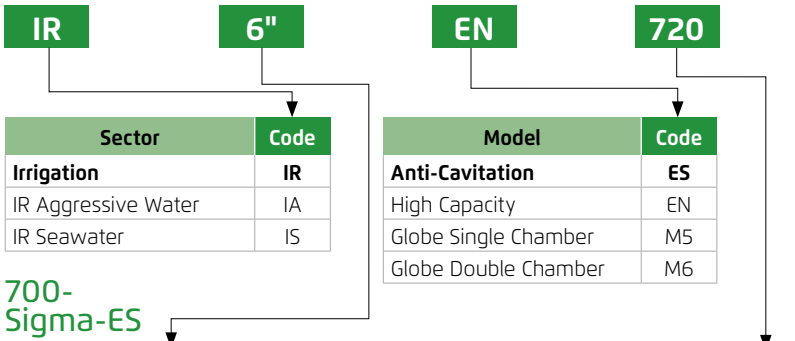
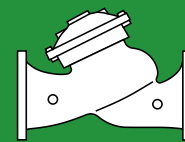

Size	
DN65	2½"
DN80	3"
DN100	4"
DN125	5"
DN150	6"
DN200	8"
DN250	10"
DN300	12"
DN350	14"
DN400	16"
DN500	20"
DN600	24"

700; 700-SIGMA-EN

Size	
DN40	1½"
DN50	2"
DN65	2½"
DN80	3"
DN100	4"
DN150	6"
DN200	8"
DN250	10"
DN300	12"
DN350 *	14" *
DN400	16"
DN450 *	18" *
DN500 *	20" *

* Only 700 series

Primary Feature	Code
Basic Valve (Double Chambered Actuator)	700
Basic Valve (Single Chambered Actuator)	705
Solenoid Controlled Valve	710
Electronic Control Valve	718
Pressure Reducing Control Valve	720
Pressure Reducing & Sustaining Valve	723
Pressure Sustaining Valve	730
Pressure Relief Valve, Quick Type	73Q
Pressure Sustaining Valve Remote Sensing Type	730R
Surge Anticipating Valve	735
Differential Pressure Sustaining Valve	736
Booster Pump Control Valve	740
Booster Pump Control & Pressure Reducing Valve	742
Booster Pump Control & Pressure Sustaining Valve	743
Deep Well Pump Electric Control Valve	745
Booster Pump & Flow Control Valve	747
Level Control Valve	750
Level Control & Pressure Sustaining Valve	753
Level & Flow Control Valve	757
Level Sustaining Valve (Reservoir Outlet)	75A
Hydraulic Check Valve	760
Flow Control Valve	770
Flow Control & Pressure Reducing Valve	772
Flow Control & Pressure Sustaining Valve	773
Flow Control, Pressure Reducing & Sustaining Valve	775
Burst Control Valve (Excessive Flow)	790
Burst Control & Pressure Reducing Valve	792
Check Valve (Lift Type)	70N
Strainer (Stone and Gravel Trap)	70F

Other primary features available on request.

700-M5

Size	
DN600	24"
DN800	32"

700-M6

Size	
DN600	24"
DN700	28"
DN750	30"
DN800	32"
DN900	36"

700-M5L

Size	
DN750	30"
DN800	32"
DN900	36"
DN1000	40"
DN1050	42"
DN1200	48"

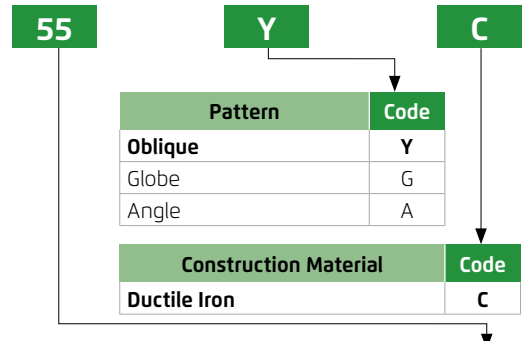

Additional Feature (Multiple Options Permitted)	Code
No Additional Feature	00
Closing and Opening Speed Control	03
Accelerated Closing	04
Hydraulic Override	09
Check-Lock	11
High Sensitivity Pilot	12*
Electronic Control	18
Check Feature	20
Solenoid Controlled & Check Feature	25
Pressure Reducing Feature	2Q
Relief Override	3Q
Electrically Selected Multi-Level Setting	45
Downstream Over Pressure Guard	48
Closing Surge Prevention	49
Electronic Multi-Level Setting - Type 4R	4R
2-Way Hydraulic Relay	50
3-Way Hydraulic Relay	54
Solenoid Controlled	55
Electric Override	59
Modulating Horizontal Float	60
Bi-Level Electric Float	65
Bi-Level Vertical Float	66
Modulating Vertical Float	67
Bi-Directional Flow	70
Altitude Pilot	80*
Modulating Altitude Control	82*
Sustaining Altitude Pilot	83*
Hydraulic Positioning	85*
Bi-Level Altitude Control	86*
Altitude Control with Bi-Directional Flow	87*
Setting Range	
2-6 meter; 7-20 feet Setting	M1
2-14 meter; 7-46 feet Setting	M6
5-22 meter; 17-72 feet Setting	M5
15-35 meter; 49-115 feet Setting	M4
25-70 meter; 82-230 feet Setting	M8
Closing at Downstream Pressure Drop	91
Double Cavitation Cage	C2
Independent Lift Check	2S
Proportional (Not available for M5)	PD

Other additional features available on request.
* Select Setting Range



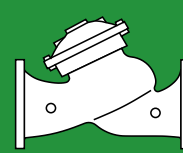

16
PG
4AC
PB
VI

End Connection		Code
Flanged	ISO-PN10	10
	ISO-PN16	16
	ISO-PN25	25
	ANSI-#150	A5
	ANSI-#300	A3
	BST-D	BD
	JIS-16	J6
	JIS-20	J2
Threaded	BSP	BP
	BSP-25 bar	PH
	NPT	NP
	NPT-25 bar	NH
	(up to 3")	

Other end connections available on request.

Voltage-Main Valve Position (When Solenoid De-Energized)			Code
24VAC, with Diode (D) - Normally Closed			4AC
24VAC, with Diode (D) - Normally Open			4AO
24VAC - Last Position			4AP
24VAC, with Ring (R) - Normally Closed			4RC
24VAC, with Ring (R) - Normally Open			4RO
24VDC - Normally Closed			4DC
24VDC - Normally Open			4DO
24VDC - Last Position			4DP
12VDC - Normally Closed			1DC
12VDC - Normally Open			1DO
12VDC - Last Position			1DP
12VDC - Latch Solenoid S-985 (3 Leads)			1DS
12VDC - Latch Solenoid S-982 (2 Leads)			2DS
9VDC - Latch Solenoid			9DS

Other electrical ratings available on request.

Tubing & Fittings		Code
Reinforced Plastic Tubing & Brass Fittings		PB
Copper Tubing & Brass Fittings		CB
St. St. 316 Tubing & Fittings		NN

Coating	Code
Polyester Green RAL 6017	PG
Polyester Blue RAL 5010	PB

Other coatings available on request.

Additional Attributes (Multiple Options Permitted)		Code
V-Port Throttling Plug		V
Large Control Filter		F
Valve Position Indicator		I
Electric Limit Switch		S
Valve Position Transmitter		Q
Flow Stem		M
Lifting Spring		L
Orifice Assembly		U
Paddle Pilot		t
Pressure Separator		d
Double Chambered (Active)		B
3-Way Control		X
Manual Selector		Z
Flow Over the Seat		O
St. St. 316 Control Accessories		N
Delrin Bearing		R
PVDF Bearing		r
EPDM Elastomers Seals & Diaphragm		E1
Viton Elastomers Seals & Diaphragm		E2
Low Preset Pressure (below 2 bar)		2
Plastic Pressure Test Point		5
Pressure Gauge		6
½" Anti Vacuum at Valve Downstream		7

Other additional attributes are available. Please consult our sales department for further information.

Reduction Ratios

700-Sigma-ES

Valve Size	Plug Type	
	Flat Disc	V-Port
DN65; 2½"	2.8	3.0
DN80; 3"	2.8	3.0
DN100; 4"	2.6	2.8
DN125; 5"	2.5	2.8
DN150; 6"	2.4	2.7
DN200; 8"	2.4	2.6
DN250; 10"	2.3	2.5
DN300; 12"	2.3	2.5
DN350; 14"	2.3	2.5
DN400; 16"	2.2	2.4
DN450; 18"	2.2	2.3
DN500; 20"	2.2	2.3
DN600; 24"	2.2	2.3

700-Sigma-EN

Valve Size	Plug Type	
	Flat Disc	V-Port
DN40; 1½"	2.8	3.0
DN50; 2"	2.8	3.0
DN550; 2½"	2.8	3.2
DN80; 3"	2.7	3.0
DN100; 4"	2.4	2.6
DN150; 6"	2.4	2.6
DN200; 8"	2.3	2.5
DN250; 10"	2.3	2.5
DN300; 12"	2.2	2.4
DN400; 16"	2.2	2.3

700-M6

Valve Size	Plug Type
DN600; 24"	2.0
DN700; 28"	
DN750; 30"	
DN800; 32"	
DN900; 36"	

- The reduction ratios are based on flow velocity of 2.0-3.0 m/sec.
- Reduction ratio may vary at extreme flow velocity & upstream pressure.



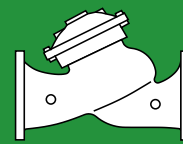

ES - Basic Valve

Double/Single Chambered Actuator

IR-ES-700-V

Size	Pattern	Connection
3"	DN80	Y Flanged
4"	DN100	Y Flanged
6"	DN150	Y Flanged
8"	DN200	Y Flanged
10"	DN250	Y Flanged

Size	Pattern	Connection
12"	DN300	Y Flanged
16"	DN400	Y Flanged
20"	DN500	Y Flanged
24"	DN600	Y Flanged



EN - Basic Valve

Double/Single Chambered Actuator

IR-EN-700

Size	Pattern	Connection
2"	DN50	Y Flanged
3"	DN80	Y Flanged
4"	DN100	Y Flanged
6"	DN150	Y Flanged
8"	DN200	Y Flanged

Size	Pattern	Connection
10"	DN250	Y Flanged
12"	DN300	Y Flanged
16"	DN400	Y Flanged
18"	DN450	Y Flanged
24"	DN600	Y Flanged



ES - Pressure Reducing Valve

with 2-Way control

IR-ES-720-V

Size	Pattern	Connection
3"	DN80	Y Flanged
4"	DN100	Y Flanged
6"	DN150	Y Flanged
8"	DN200	Y Flanged
10"	DN250	Y Flanged

Size	Pattern	Connection
12"	DN300	Y Flanged
16"	DN400	Y Flanged
20"	DN500	Y Flanged
24"	DN600	Y Flanged



ES - Pressure Reducing Valve

with 2-Way control, Solenoid Control

IR-ES-720-55-V

Size	Pattern	Connection
3"	DN80	Y Flanged
4"	DN100	Y Flanged
6"	DN150	Y Flanged
8"	DN200	Y Flanged
10"	DN250	Y Flanged

Size	Pattern	Connection
12"	DN300	Y Flanged
16"	DN400	Y Flanged
20"	DN500	Y Flanged
24"	DN600	Y Flanged



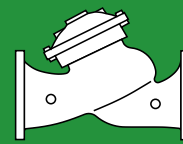

EN - Pressure Reducing Valve, Free-Flow Response

IR-EN-720-X

Size	Pattern	Connection
2"	DN50	Y Flanged
3"	DN80	Y Flanged
4"	DN100	Y Flanged
6"	DN150	Y Flanged
8"	DN200	Y Flanged

Size	Pattern	Connection
10"	DN250	Y Flanged
12"	DN300	Y Flanged
16"	DN400	Y Flanged
18"	DN450	Y Flanged
24"	DN600	Y Flanged



EN - Pressure Reducing Valve, Free-Flow Response

with Solenoid Control

IR-EN-720-55-X

Size	Pattern	Connection
2"	DN50	Y Flanged
3"	DN80	Y Flanged
4"	DN100	Y Flanged
6"	DN150	Y Flanged
8"	DN200	Y Flanged

Size	Pattern	Connection
10"	DN250	Y Flanged
12"	DN300	Y Flanged
16"	DN400	Y Flanged
18"	DN450	Y Flanged
24"	DN600	Y Flanged



ES - Proportional Pressure Reducing Valve

IR-ES-720-PD-V

Size	Pattern	Connection
3"	DN80	Y Flanged
4"	DN100	Y Flanged
6"	DN150	Y Flanged
8"	DN200	Y Flanged
10"	DN250	Y Flanged

Size	Pattern	Connection
12"	DN300	Y Flanged
16"	DN400	Y Flanged
20"	DN500	Y Flanged
24"	DN600	Y Flanged



ES - Pressure Reducing & Sustaining Valve

with 2-Way control

IR-ES-723-V

Size	Pattern	Connection
3"	DN80	Y Flanged
4"	DN100	Y Flanged
6"	DN150	Y Flanged
8"	DN200	Y Flanged
10"	DN250	Y Flanged

Size	Pattern	Connection
12"	DN300	Y Flanged
16"	DN400	Y Flanged
20"	DN500	Y Flanged
24"	DN600	Y Flanged



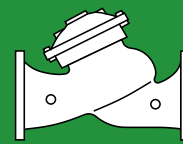

ES - Pressure Reducing & Sustaining Valve

with 2-Way control, Solenoid Control

IR-ES-723-55-V

Size	Pattern	Connection
3"	DN80	Y Flanged
4"	DN100	Y Flanged
6"	DN150	Y Flanged
8"	DN200	Y Flanged
10"	DN250	Y Flanged

Size	Pattern	Connection
12"	DN300	Y Flanged
16"	DN400	Y Flanged
20"	DN500	Y Flanged
24"	DN600	Y Flanged



ES - Pressure Relief / Sustaining Valve

with 2-Way control

IR-ES-730-V

Size	Pattern	Connection
3"	DN80	Y Flanged
4"	DN100	Y Flanged
6"	DN150	Y Flanged
8"	DN200	Y Flanged
10"	DN250	Y Flanged

Size	Pattern	Connection
12"	DN300	Y Flanged
16"	DN400	Y Flanged
20"	DN500	Y Flanged
24"	DN600	Y Flanged



ES - Pressure Relief / Sustaining Valve

with 2-Way control, with Solenoid Control

IR-ES-730-55-V

Size	Pattern	Connection
3"	DN80	Y Flanged
4"	DN100	Y Flanged
6"	DN150	Y Flanged
8"	DN200	Y Flanged
10"	DN250	Y Flanged

Size	Pattern	Connection
12"	DN300	Y Flanged
16"	DN400	Y Flanged
20"	DN500	Y Flanged
24"	DN600	Y Flanged



Quick Pressure Relief Valve

IR-73Q

Size	Pattern	Connection
2"	DN50	Y/A Flanged
3"	DN80	Y/A Flanged
4"	DN100	Y/A Flanged
6"	DN150	Y/A Flanged
8"	DN200	Y/A Flanged

Size	Pattern	Connection
10"	DN250	Y/A Flanged
12"	DN300	Y/A Flanged
16"	DN400	Y/A Flanged
18"	DN450	Y/A Flanged
24"	DN600	Y Flanged



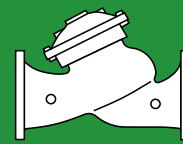

ES - Surge-Anticipating Control Valve

IR-ES-735-M

Size	Pattern	Connection
3"	DN80	Y Flanged
4"	DN100	Y Flanged
6"	DN150	Y Flanged
8"	DN200	Y Flanged
10"	DN250	Y Flanged

Size	Pattern	Connection
12"	DN300	Y Flanged
16"	DN400	Y Flanged
20"	DN500	Y Flanged
24"	DN600	Y Flanged



ES - Surge-Anticipating Valve with Solenoid Control

with Solenoid Control

IR-ES-735-55-M

Size	Pattern	Connection
3"	DN80	Y Flanged
4"	DN100	Y Flanged
6"	DN150	Y Flanged
8"	DN200	Y Flanged
10"	DN250	Y Flanged

Size	Pattern	Connection
12"	DN300	Y Flanged
16"	DN400	Y Flanged
20"	DN500	Y Flanged
24"	DN600	Y Flanged



EN - Pump Control Valve, with Independent Flow Check

IR-EN-740-2S-03-S

Size	Pattern	Connection
2"	DN50	Y Flanged
3"	DN80	Y Flanged
4"	DN100	Y Flanged
6"	DN150	Y Flanged
8"	DN200	Y Flanged

Size	Pattern	Connection
10"	DN250	Y Flanged
12"	DN300	Y Flanged
16"	DN400	Y Flanged
18"	DN450	Y Flanged
24"	DN600	Y Flanged



EN - Level Control Valve, Modulating Horizontal Float

IR-EN-750-60

Size	Pattern	Connection
2"	DN50	Y Flanged
3"	DN80	Y Flanged
4"	DN100	Y Flanged
6"	DN150	Y Flanged
8"	DN200	Y Flanged

Size	Pattern	Connection
10"	DN250	Y Flanged
12"	DN300	Y Flanged
16"	DN400	Y Flanged
18"	DN450	Y Flanged
24"	DN600	Y Flanged



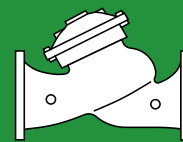

EN - Level Control Valve, Bi-level Vertical Float

IR-EN-750-66-B

Size	Pattern	Connection
2"	DN50	Y Flanged
3"	DN80	Y Flanged
4"	DN100	Y Flanged
6"	DN150	Y Flanged
8"	DN200	Y Flanged

Size	Pattern	Connection
10"	DN250	Y Flanged
12"	DN300	Y Flanged
16"	DN400	Y Flanged
18"	DN450	Y Flanged
24"	DN600	Y Flanged



EN - Level Control Valve, Modulating Vertical Float

IR-EN-750-67

Size	Pattern	Connection
2"	DN50	Y Flanged
3"	DN80	Y Flanged
4"	DN100	Y Flanged
6"	DN150	Y Flanged
8"	DN200	Y Flanged

Size	Pattern	Connection
10"	DN250	Y Flanged
12"	DN300	Y Flanged
16"	DN400	Y Flanged
18"	DN450	Y Flanged
24"	DN600	Y Flanged



EN - Level Control & Pressure-Sustaining Valve Bi-Level Electric Float

IR-EN-753-65

Size	Pattern	Connection
2"	DN50	Y Flanged
3"	DN80	Y Flanged
4"	DN100	Y Flanged
6"	DN150	Y Flanged
8"	DN200	Y Flanged

Size	Pattern	Connection
10"	DN250	Y Flanged
12"	DN300	Y Flanged
16"	DN400	Y Flanged
18"	DN450	Y Flanged
24"	DN600	Y Flanged



EN - Level Control & Pressure-Sustaining Valve, Bi-Level Vertical Float

IR-EN-753-66

Size	Pattern	Connection
2"	DN50	Y Flanged
3"	DN80	Y Flanged
4"	DN100	Y Flanged
6"	DN150	Y Flanged
8"	DN200	Y Flanged

Size	Pattern	Connection
10"	DN250	Y Flanged
12"	DN300	Y Flanged
16"	DN400	Y Flanged
18"	DN450	Y Flanged
24"	DN600	Y Flanged



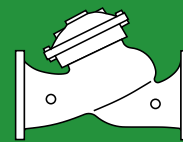

EN - Level Control and Flow Control Valve Bi-Level Vertical Float

IR-EN-757-66-U

Size	Pattern	Connection
2"	DN50	Y Flanged
3"	DN80	Y Flanged
4"	DN100	Y Flanged
6"	DN150	Y Flanged
8"	DN200	Y Flanged

Size	Pattern	Connection
10"	DN250	Y Flanged
12"	DN300	Y Flanged
16"	DN400	Y Flanged
18"	DN450	Y Flanged
24"	DN600	Y Flanged



ES - Flow Control Valve

with Paddle Type Pilot

IR-ES-770-tV

Size	Pattern	Connection
3"	DN80	Y Flanged
4"	DN100	Y Flanged
6"	DN150	Y Flanged
8"	DN200	Y Flanged
10"	DN250	Y Flanged

Size	Pattern	Connection
12"	DN300	Y Flanged
16"	DN400	Y Flanged
20"	DN500	Y Flanged
24"	DN600	Y Flanged



ES - Flow Control Valve

with Paddle Type Pilot, Solenoid Control

IR-ES-770-55-tV

Size	Pattern	Connection
3"	DN80	Y Flanged
4"	DN100	Y Flanged
6"	DN150	Y Flanged
8"	DN200	Y Flanged
10"	DN250	Y Flanged

Size	Pattern	Connection
12"	DN300	Y Flanged
16"	DN400	Y Flanged
20"	DN500	Y Flanged
24"	DN600	Y Flanged



ES - Flow Control & Pressure Reducing Valve

with Paddle Type Pilot

IR-ES-772-tV

Size	Pattern	Connection
3"	DN80	Y Flanged
4"	DN100	Y Flanged
6"	DN150	Y Flanged
8"	DN200	Y Flanged
10"	DN250	Y Flanged

Size	Pattern	Connection
12"	DN300	Y Flanged
16"	DN400	Y Flanged
20"	DN500	Y Flanged
24"	DN600	Y Flanged



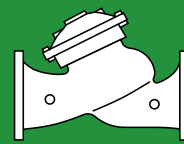

ES - Flow Control & Pressure Reducing Valve

with Paddle Type Pilot, Solenoid Control

IR-ES-772-55-tV

Size	Pattern	Connection
3"	DN80	Y Flanged
4"	DN100	Y Flanged
6"	DN150	Y Flanged
8"	DN200	Y Flanged
10"	DN250	Y Flanged

Size	Pattern	Connection
12"	DN300	Y Flanged
16"	DN400	Y Flanged
20"	DN500	Y Flanged
24"	DN600	Y Flanged



Flow Control & Pressure Sustaining Valve

with Paddle Type Pilot

IR-ES-773-tV

Size	Pattern	Connection
3"	DN80	Y Flanged
4"	DN100	Y Flanged
6"	DN150	Y Flanged
8"	DN200	Y Flanged
10"	DN250	Y Flanged

Size	Pattern	Connection
12"	DN300	Y Flanged
16"	DN400	Y Flanged
20"	DN500	Y Flanged
24"	DN600	Y Flanged



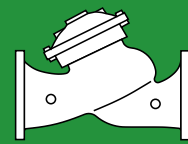

Packing Specifications

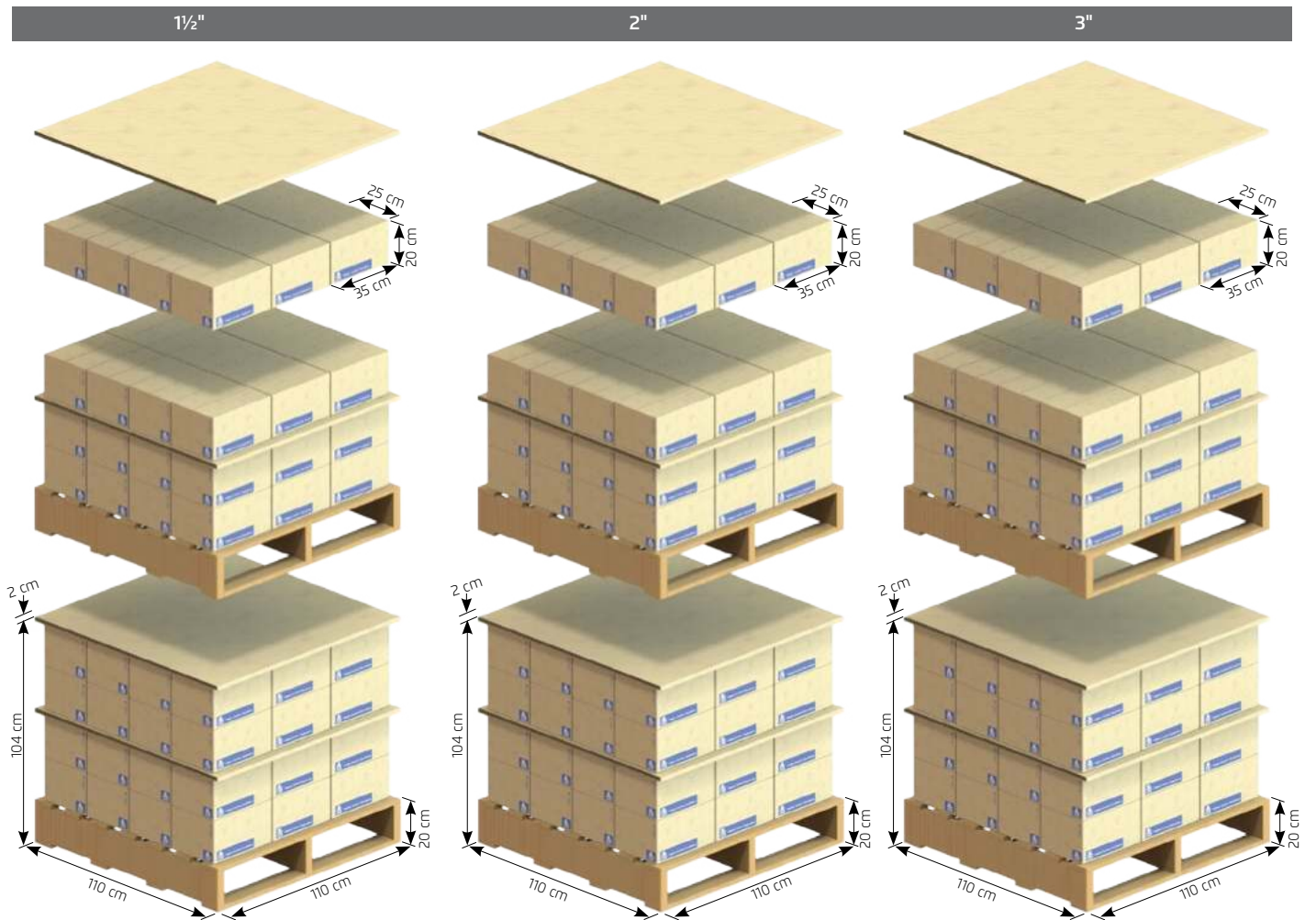

Per Box

Valve Size	Box					
	Units	Length [cm]	Width [cm]	Height [cm]	Weight [kg]	Volume [m ³]
1½"-SIGMA-EN	2	35	25	20	7	0.02
2"-SIGMA-EN	1	35	25	20	8	0.02
2½"-SIGMA-ES	1	35	25	20	8	0.02
3"-SIGMA-ES	1	35	25	20	17	0.02
3"-SIGMA-EN	1	35	35	25	19	0.03

Per Pallet

Valve Size	Pallet							
	Number of Boxes	Number of Levels	Number of Units	Length [cm]	Width [cm]	Height [cm]	Gross Weight [kg]	Volume [m ³]
1½"-SIGMA-EN	48	4	96	110	110	100	692	1.3
2"-SIGMA-EN	48	4	48	110	110	100	404	1.3
2½"-SIGMA-ES	48	4	48	110	110	100	404	1.3
3"-SIGMA-ES	48	4	48	110	110	100	836	1.3
3"-SIGMA-EN	27	3	27	110	110	90	533	1.1



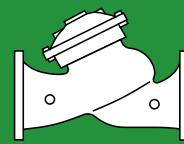

Packing Specifications 700-Sigma-EN Series

4"

6"

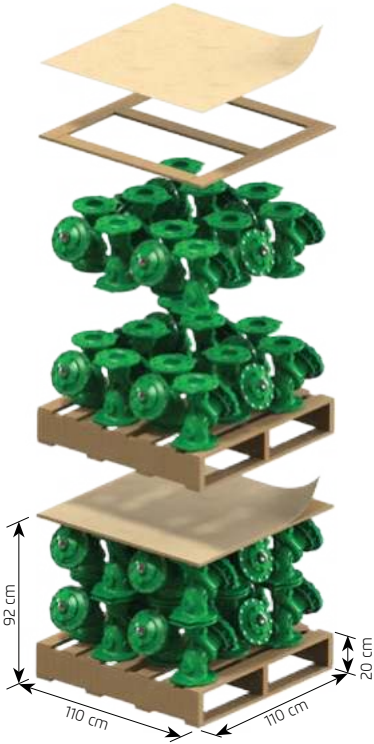

4"

No. of Layers	2
No. of Units	20
Length [cm]	110
Width [cm]	110
Height [cm]	92
Gross Weight	680
Volume [m ³]	1.12

6"

No. of Layers	2
No. of Units	12
Length [cm]	110
Width [cm]	110
Height [cm]	115
Gross Weight	860
Volume [m ³]	1.4

8"

10"

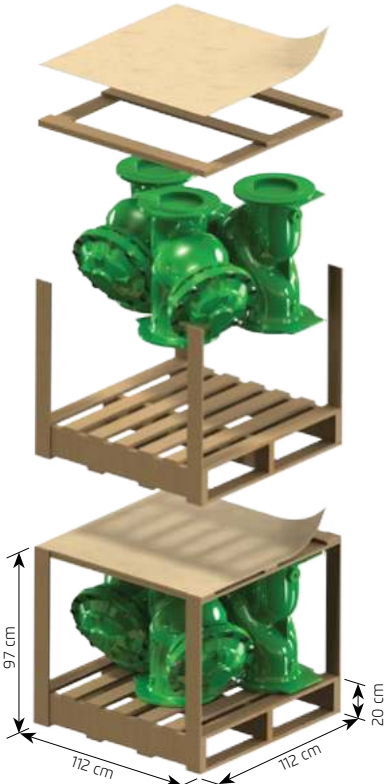

8"

No. of Layers	1
No. of Units	4
Length [cm]	110
Width [cm]	110
Height [cm]	84
Gross Weight	480
Volume [m ³]	1.02

10"

No. of Layers	1
No. of Units	3
Length [cm]	110
Width [cm]	110
Height [cm]	85
Gross Weight	614
Volume [m ³]	1.03

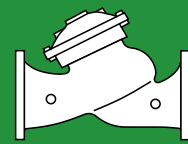

Packing Specifications 700-Sigma-ES Series

4"

6"

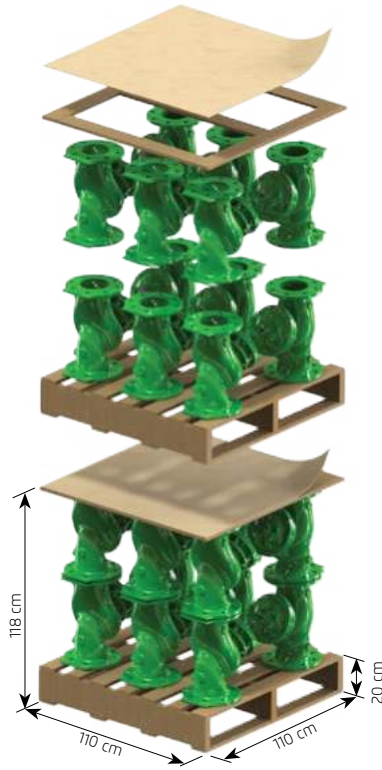

4"	
No. of Layers	2
No. of Units	20
Length [cm]	110
Width [cm]	110
Height [cm]	92
Gross Weight	600
Volume [m ³]	1.12

6"	
No. of Layers	2
No. of Units	12
Length [cm]	110
Width [cm]	110
Height [cm]	115
Gross Weight	680
Volume [m ³]	1.4

8"

10"

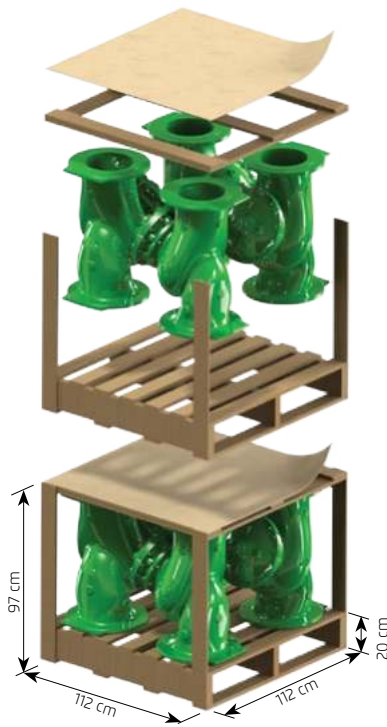
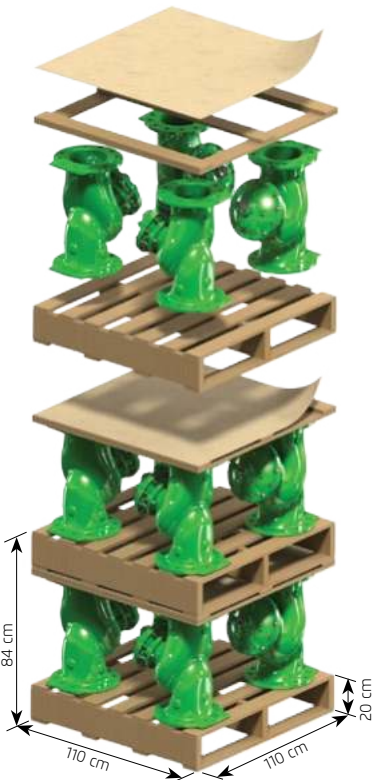

8"	
No. of Layers	1
No. of Units	4
Length [cm]	110
Width [cm]	110
Height [cm]	80
Gross Weight	400
Volume [m ³]	1.02

10"	
No. of Layers	1
No. of Units	4
Length [cm]	110
Width [cm]	110
Height [cm]	80
Gross Weight	612
Volume [m ³]	1.03

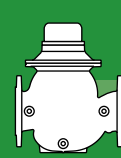

IR-900 Series Hydrometer



The BERMAD IR-900 Series Hydrometer is a unique product integrating both a vertical turbine Woltman-type water meter and a diaphragm actuated control valve.

The flow metering unit is vertical to the pipeline and includes an impeller with integrated inlet and outlet flow straighteners, eliminating the need for straightening distances, enabling vertical installation, and ensuring accuracy during control tasks. The raised seal seat results in remarkable cavitation resistance due to the valve body's distance from the flow.

IR-900 provides the full spectrum of metering functions – from simple visual readout, through non-computerized dose control, to pulse output for computerized data capture and control - while simultaneously allowing for numerous control valve features such as pressure, level and flow control.

IR-900 Series range in diameter sizes of 1½"-10".

Features and Benefits

- Integrated "All-in-One" Control Valve
 - Saves space, cost and maintenance
- Hydraulically Controlled Hydrometer
 - Line pressure driven
- Magnetic Drive Register:
 - Analog rotating hands display
 - Water-free gear train mechanism
 - Various pulse combinations
- Internal Inlet & Outlet Flow Straighteners
 - Saves on straightening distances of pipe
 - Maintains accuracy
- Integrated Flow Metering Calibration Device
 - Precise measurement
- User-Friendly Design
 - Simple in-line inspection and service

Typical Applications

- Computerized Irrigation Systems
 - Irrigation Control Head
 - In-Field Control Head
- Remote Flow Data Read-Out
 - Flow Monitoring & Leakage Control
 - Water Treatment Systems
 - Volumetric Irrigation Systems

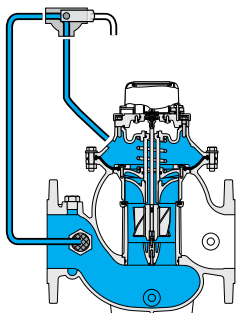
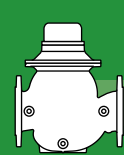

Hydrometer Closed

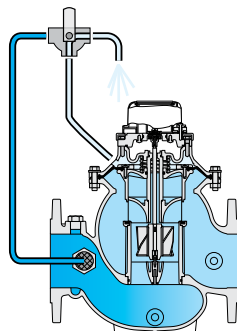

Hydrometer Open

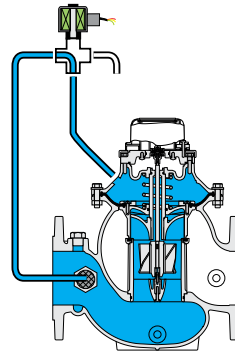

Solenoid Open
Hydrometer Closed

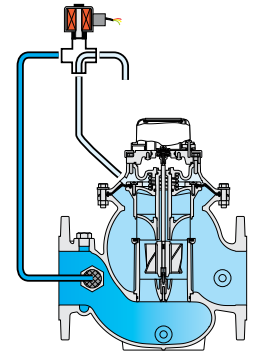

Solenoid Closed
Hydrometer Open

On/Off Modes, Local Manual Control

Line pressure is applied to the control chamber of the hydrometer, through the override Cock-Valve. This creates a hydraulic force that moves the valve to the closed position and provides drip tight sealing. Discharging pressure from the control chamber to the atmosphere causes the line pressure under the plug to open the hydrometer, measuring the flow rate.

Flow Chart

Globe Pattern

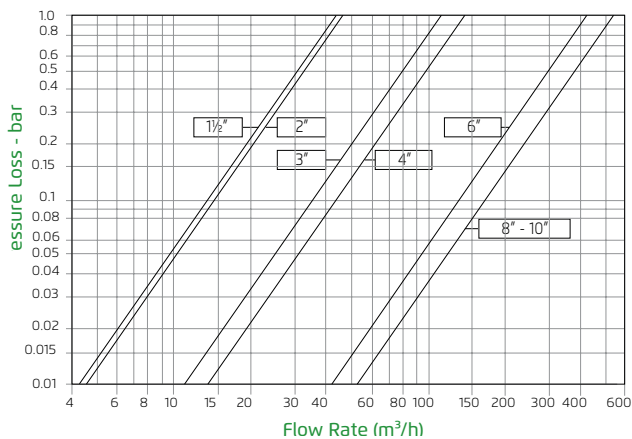

On/Off Modes, Solenoid Controlled

Line pressure is applied to the control chamber of the hydrometer, through the opened 3-way solenoid. This creates a hydraulic force that moves the valve to the closed position and provides drip tight sealing. Closing the Solenoid causes it to switch, discharging pressure from the control chamber.

This in turn causes the line pressure under the plug to open the hydrometer, measuring the flow.

90° Angle Pattern

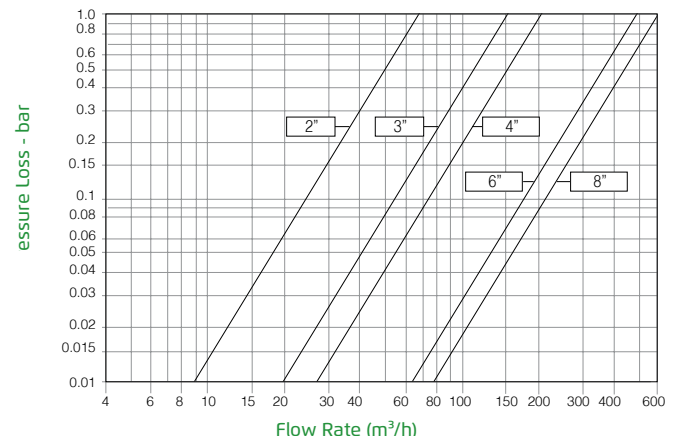

Standards: 900-E - Electronic; 900-M Series Approved to MID 2004/22/EC

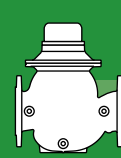

Globe Pattern

Connection Type		Threaded		
Size	DN	40	50	80R
	inch	1½	2	3R
LM		320	330	250
L		250	250	250
W		137	137	137
H		300	300	300
R		95	95	79
Weight (Kg)		7.2	7.3	7.3

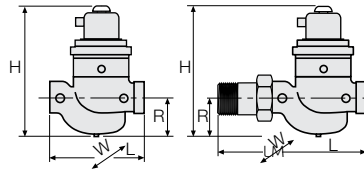

Globe Pattern

Connection Type		Threaded						Grooved			
Size	DN	40	50	80R	80	100	150	200	250	100	150
	inch	1½	2	3R	3	4	6	8	10	4	6
L		250	250	310	300	350	500	600	600	600	600
W		150	165	200	210	250	380	380	405	380	405
H		300	300	321	405	460	623	633	633	633	633
R		95	95	100	123	137	216	228	228	228	228
Weight (Kg)		10.6	12.7	18.8	23	30	70	92	140	92	140

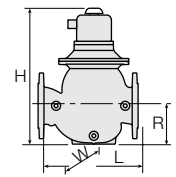

90° Angle Pattern

Connection Type		Flanged				
Size	DN	50	80	100	150	200
	inch	2	3	4	6	8
L		120	150	180	250	250
W		137	210	250	380	380
H		322	425	480	610	610
R		125	196	225	306	280
Weight (Kg)		7.9	25.5	35.8	76.4	82.2

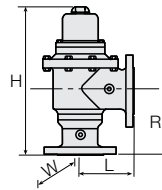

Available Patterns, Size & End Connections

Connection Type		Flanged								
Size	DN	40	50	65	80R	80	100	150	200	250
	inch	1½	2	2½	3R	3	4	6	8	10
Threaded		G	G & A		G					
Threaded (Male)		G	G							
Flanged		G	G	G	G	G & A	G & A	G & A	G & A	G
Flange Inlet \ Thread Outlet			A		G					

G = Globe, A = Angle 90°

Technical Data

Connections Standard:

Flanged: ISO 7005-2 (PN10 & 16)

Threaded: Rp ISO 7/1 BSP.P or NPT

Operating Pressure Ranges:

PN16: 0.7-16 bar

For lower pressure requirements, consult factory

Temperature: Water up to 50°C

BERMAD Irrigation

Technical Data

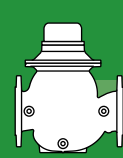

Table of Contents

900 Series





900-M

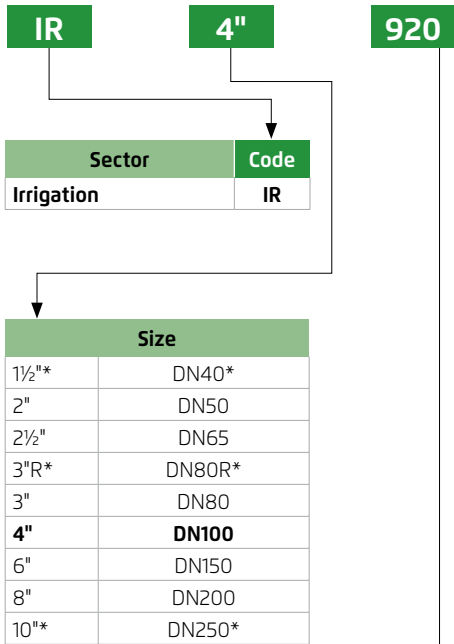

* Globe only

Primary Features	Code
Basic	900
Basic Low Pressure	90L
Water Meter	901
Solenoid Controlled Valve	910
Electronic Control Valve	918
Pressure Reducing Valve	920
Pressure Reducing & Sustaining Valve	923
Flow Control Valve, Constant Downstream Pressure	927
Pressure Sustaining Valve	930
Level Control Valve	950
Level Control - Low Pressure	95L
Level Control & Pressure Sustaining Valve	953
Level & Flow Control	957
Flow Control Valve	970
Flow Control & Pressure Reducing Control Valve	972
Flow Control & Pressure Sustaining Control Valve	973
Flow Control, Pressure Reducing & Sustaining Valve	975

Other primary features available on request.

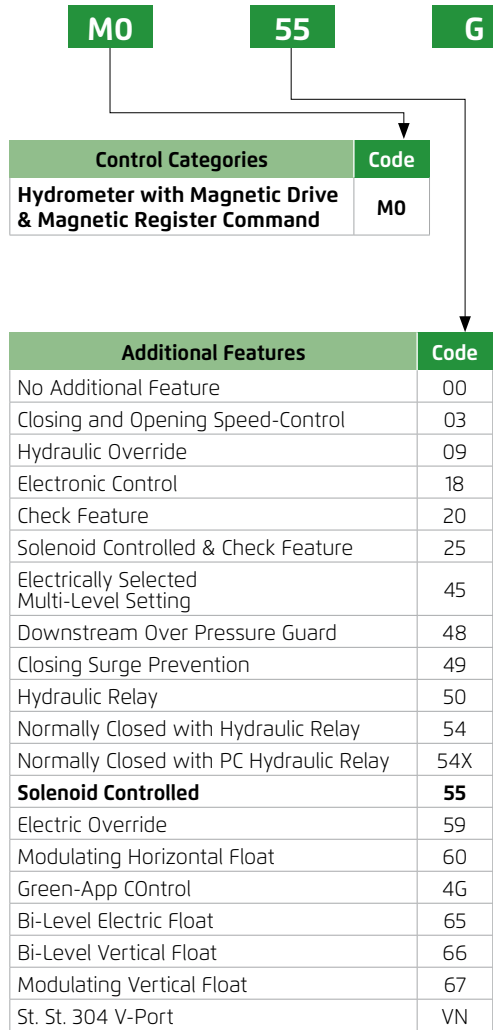

Other additional features available on request.

Construction Materials	Code
Ductile Iron	C

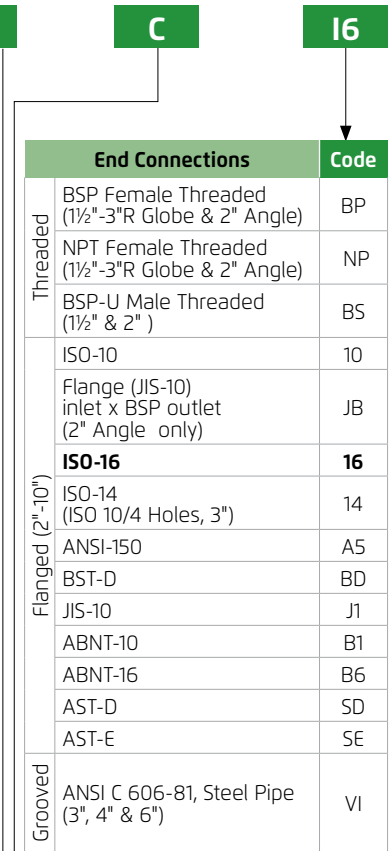

Other end connections available on request.



900-M

PG

Coating	Code
Polyester Green RAL 6017	PG

Other coatings available on request.

4AC

Voltage-Main Valve Position (When Solenoid De-Energized)	Code
24VAC, with Diode (D) - Normally Closed	4AC
24VAC, with Diode (D) - Normally Open	4AO
24VAC - Last Position	4AP
24VAC, with Ring (R) - Normally Closed	4RC
24VAC, with Ring (R) - Normally Open	4RO
24VDC - Normally Closed	4DC
24VDC - Normally Open	4DO
24VDC - Last Position	4DP
12VDC - Normally Closed	1DC
12VDC - Normally Open	1DO
12VDC - Last Position	1DP
12VDC - Latch Solenoid S-985 (3 Leads)	1DS
12VDC - Latch Solenoid S-982 (2 Leads)	2DS
9VDC - Latch Solenoid	9DS

Other electrical ratings available on request.

PP

Pulse Type	Pulse Rate m ³	Code
No Pulse	No Pulse m ³	RNP
Reed Switch 1 Pulse	Reed 100 Liter	R02
	Reed 1 m³	R03
	Reed 10 m ³	R04
Reed Switch 2 Pulse	REED 100L + REED 1 m ³	R23
	REED 1m ³ + REED 10 m ³	R34

R03

Additional Attributes Unlimited Selection	Code
3-Way Control Loop	X
Plastic Control Accessories	K
Metal Control Accessories	R
Homologation Approved	L
BSP-U Union Records Assembly (1.5" & 2" only)	M
Orifice Assembly	U
Paddle Flow Control Pilot	V
Large Control Filter	F
Manual Selector	Z
Low Preset Pressure (below 2 bar)	2
Plastic Pressure Test Point	5
Pressure Gauge	6
½" Anti Vacuum at Valve Downstream	7

Other additional attributes are available. Please consult Customer Service for further information.

KX

Tubing & Fittings

Tubing & Fittings	Code
Plastic Tubing & Fittings	PP
Plastic Reinforced Tubing & Brass Fittings	PB
Copper Tubing & Brass Fittings	CB

Hydrometer Magnetic Register Pulses & size Availability

Size	Pulse per		
	100 Liter	1m ³	10m ³
1½"-4"; DN40-DN100	Y	Y	N
6"-10"; DN150-DN250	N	Y	Y

Note: Pulse combinations are available according to "Pulse Rate Table".

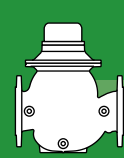

Hydrometer

Magnetic (M0) Drive

IR-900-M0

Size	Pattern	Connection
1½"	DN40	G Threaded
2"	DN50	G Threaded
		A Flanged
2½"	DN65	G Flanged
3"R	DN80R	G Threaded
		A Flanged/Grooved
3"	DN80	G Flanged/Grooved
		A Flanged

Size	Pattern	Connection
4"	DN100	G Flanged/Grooved
		A Flanged
6"	DN150	G Flanged/Grooved
		A Flanged
8"	DN200	G Flanged/Grooved
		A Flanged
10"	DN250	G Flanged/Grooved



Hydrometer

Magnetic (M0) Drive with Manual Selector, Plastic Fittings

IR-900-M0-KZ

Size	Pattern	Connection
1½"	DN40	G Threaded
2"	DN50	G Threaded
		A Flanged
2½"	DN65	G Flanged
3"R	DN80R	G Threaded

Size	Pattern	Connection
3"R	DN80R	G Flanged
3"	DN80	G Flanged/Grooved
		A Flanged
4"	DN100	G Flanged/Grooved
		A Flanged



Hydrometer

Magnetic (M0) Drive with Manual Selector, Metal Fittings

IR-900-M0-RZ

Size	Pattern	Connection
1½"	DN40	G Threaded
2"	DN50	G Threaded
		A Flanged
2½"	DN65	G Threaded
		A Flanged
3"R	DN80R	G Flanged/Grooved
		A Flanged
3"	DN80	G Flanged/Grooved
		A Flanged

Size	Pattern	Connection
4"	DN100	G Flanged/Grooved
		A Flanged
6"	DN150	G Flanged/Grooved
		A Flanged
8"	DN200	G Flanged/Grooved
		A Flanged
10"	DN250	G Flanged/Grooved





Hydrometer, Solenoid Controlled

Magnetic (MO) Drive with Plastic Accessories (K)

IR-910-MO-KX

Solenoid S-390-3W; S-400

Size	Pattern	Connection
1½"	DN40	G Threaded
2"	DN50	G Threaded
		A Flanged
2½"	DN65	G Flanged
3"R	DN80R	G Threaded

Size	Pattern	Connection
3"R	DN80R	G Flanged
3"	DN80	G Flanged/ Grooved
		A Flanged
4"	DN100	G Flanged/ Grooved
		A Flanged



Hydrometer, Solenoid Controlled

Magnetic (MO) Drive with Metal Accessories (R)

IR-910-MO-RX

Solenoid 3W

Size	Pattern	Connection
1½"	DN40	G Threaded
2"	DN50	G Threaded
		A Flanged
2½"	DN65	G Flanged
3"R	DN80R	G Threaded
		A Flanged/ Grooved
3"	DN80	G Flanged/ Grooved
		A Flanged

Size	Pattern	Connection
4"	DN100	G Flanged/ Grooved
		A Flanged
6"	DN150	G Flanged/ Grooved
		A Flanged
8"	DN200	G Flanged/ Grooved
		A Flanged
10"	DN250	G Flanged/ Grooved



Pressure Reducing Hydrometer, 2-Way

Magnetic (MO) Drive with Metal Pilot and Accessories (R)

IR-920-MO-2W-R

Size	Pattern	Connection
1½"	DN40	G Threaded
2"	DN50	G Threaded
		A Flanged
2½"	DN65	G Flanged
3"R	DN80R	G Threaded
		A Flanged/ Grooved
3"	DN80	G Flanged/ Grooved
		A Flanged

Size	Pattern	Connection
4"	DN100	G Flanged/ Grooved
		A Flanged
6"	DN150	G Flanged/ Grooved
		A Flanged
8"	DN200	G Flanged/ Grooved
		A Flanged
10"	DN250	G Flanged/ Grooved



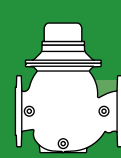

Pressure Reducing Hydrometer, 3-Way

Magnetic (M0) Drive with Manual Selector, Plastic Pilot and Accessories (K)

IR-920-M0-KXZ

Size	Pattern	Connection
1½"	DN40	G Threaded
2"	DN50	G Threaded
		A Flanged
2½"	DN65	G Flanged
3"R	DN80R	G Threaded

Size	Pattern	Connection
3"R	DN80R	G Flanged
3"	DN80	G Flanged/Grooved
		A Flanged
4"	DN100	G Flanged/Grooved
		A Flanged



Pressure Reducing Hydrometer, with Hydraulic Control, 2-Way

Magnetic (M0) Drive with Metal Pilot and Accessories (R)

IR-920-M0-50-2W-R

Size	Pattern	Connection
1½"	DN40	G Threaded
2"	DN50	G Threaded
		A Flanged
		G Threaded
2½"	DN65	G Flanged
3"R	DN80R	G Threaded
		A Flanged/Grooved
3"	DN80	G Flanged/Grooved
		A Flanged

Size	Pattern	Connection
4"	DN100	G Flanged/Grooved
		A Flanged
6"	DN150	G Flanged/Grooved
		A Flanged
8"	DN200	G Flanged/Grooved
		A Flanged
10"	DN250	G Flanged/Grooved



Pressure Reducing Hydrometer, with Hydraulic Control, 3-Way

Magnetic (M0) Drive with Manual Selector, Plastic Pilot and Accessories (K)

IR-920-M0-50-KXZ

Size	Pattern	Connection
1½"	DN40	G Threaded
2"	DN50	G Threaded
		A Flanged
		G Threaded
2½"	DN65	G Flanged
3"R	DN80R	G Threaded

Size	Pattern	Connection
3"R	DN80R	G Flanged
3"	DN80	G Flanged/Grooved
		A Flanged
4"	DN100	G Flanged/Grooved
		A Flanged





Pressure Reducing Hydrometer, Solenoid Controlled, 2-Way

Magnetic (MO) Drive with Metal Pilot and Accessories (R)

IR-920-M0-55-2W-R

solenoid 2W

Size	Pattern	Connection
1½"	DN40	G Threaded
2"	DN50	G Threaded
		A Flanged
	A Threaded	
2½"	DN65	G Flanged
3"R	DN80R	G Threaded
		A Flanged/Grooved
3"	DN80	G Flanged/Grooved
		A Flanged

Size	Pattern	Connection
4"	DN100	G Flanged/Grooved
	A Flanged	
6"	DN150	G Flanged/Grooved
	A Flanged	
8"	DN200	G Flanged/Grooved
	A Flanged	
10"	DN250	G Flanged/Grooved



Pressure Reducing Hydrometer, Solenoid Controlled, 3-Way

Magnetic (MO) Drive with Plastic Pilot and Accessories (K)

IR-920-M0-55-KX

Solenoid S-390 / S-400

Size	Pattern	Connection
1½"	DN40	G Threaded
2"	DN50	G Threaded
		A Flanged
	A Threaded	
2½"	DN65	G Flanged
3"R	DN80R	G Threaded

Size	Pattern	Connection
3"R	DN80R	G Flanged
3"	DN80	G Flanged/Grooved
		A Flanged
4"	DN100	G Flanged/Grooved
		A Flanged



Pressure Reducing & Sustaining Hydrometer, 2-Way

Magnetic (MO) Drive with Metal Pilot and Accessories (R)

IR-923-M0-2W-R

Size	Pattern	Connection
1½"	DN40	G Threaded
2"	DN50	G Threaded
		A Flanged
	A Threaded	
2½"	DN65	G Flanged
3"R	DN80R	G Threaded
		A Flanged/Grooved
3"	DN80	G Flanged/Grooved
		A Flanged

Size	Pattern	Connection
4"	DN100	G Flanged/Grooved
	A Flanged	
6"	DN150	G Flanged/Grooved
	A Flanged	
8"	DN200	G Flanged/Grooved
	A Flanged	
10"	DN250	G Flanged/Grooved



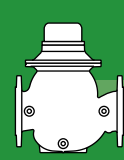

Pressure Reducing & Sustaining Hydrometer, 3-Way

Magnetic (M0) Drive with Manual Selector, Plastic Pilot and Accessories (K)

IR-923-M0-KXZ

Size	Pattern	Connection
1½"	DN40	G Threaded
2"	DN50	G Threaded
		A Flanged
2½"	DN65	G Flanged
3"R	DN80R	G Threaded

Size	Pattern	Connection
3"R	DN80R	G Flanged
3"	DN80	G Flanged/Grooved
		A Flanged
4"	DN100	G Flanged/Grooved
		A Flanged



Pressure Sustaining Hydrometer, 2-Way

Magnetic (M0) Drive with Metal Pilot and Accessories (R)

IR-930-M0-2W-R

Size	Pattern	Connection
1½"	DN40	G Threaded
2"	DN50	G Threaded
		A Flanged
2½"	DN65	G Flanged
		A Threaded
3"R	DN80R	G Flanged/Grooved
		A Flanged
3"	DN80	G Flanged/Grooved
		A Flanged

Size	Pattern	Connection
4"	DN100	G Flanged/Grooved
		A Flanged
6"	DN150	G Flanged/Grooved
		A Flanged
8"	DN200	G Flanged/Grooved
		A Flanged
10"	DN250	G Flanged/Grooved



Pressure Sustaining Hydrometer, 3-Way

Magnetic (M0) Drive with Manual Selector, Plastic Pilot and Accessories (K)

IR-930-M0-KXZ

Size	Pattern	Connection
1½"	DN40	G Threaded
2"	DN50	G Threaded
		A Flanged
2½"	DN65	G Flanged
		A Threaded
3"R	DN80R	G Threaded

Size	Pattern	Connection
3"R	DN80R	G Flanged
3"	DN80	G Flanged/Grooved
		A Flanged
4"	DN100	G Flanged/Grooved
		A Flanged





Flow Control Hydrometer, Servo

Magnetic (MO) Drive with Manual Selector, Plastic Pilot and Accessories (K)

IR-970-M0-KVZ

Size	Pattern	Connection
1½"	DN40	G Threaded
2"	DN50	G Threaded
		A Flanged
2½"	DN65	G Flanged
3"R	DN80R	G Threaded

Size	Pattern	Connection
3"R	DN80R	G Flanged
3"	DN80	G Flanged/ Grooved
		A Flanged
4"	DN100	G Flanged/ Grooved
		A Flanged



Flow Control Hydrometer with Hydraulic Control, Servo

Magnetic (MO) Drive with Manual Selector, Metal Pilot and Accessories (R)

IR-970-M0-50-RVZ

Size	Pattern	Connection
1½"	DN40	G Threaded
2"	DN50	G Threaded
		A Flanged
2½"	DN65	G Flanged
		A Threaded
3"R	DN80R	G Flanged/ Grooved
		A Flanged
3"	DN80	G Flanged/ Grooved
		A Flanged

Size	Pattern	Connection
4"	DN100	G Flanged/ Grooved
		A Flanged
6"	DN150	G Flanged/ Grooved
		A Flanged
8"	DN200	G Flanged/ Grooved
		A Flanged
10"	DN250	G Flanged/ Grooved



Flow Control & Pressure Reducing Hydrometer, 2-Way

Magnetic (MO) Drive with Manual Selector, Metal Pilot and Accessories (R)

IR-972-M0-RVZ

Size	Pattern	Connection
1½"	DN40	G Threaded
2"	DN50	G Threaded
		A Flanged
2½"	DN65	G Flanged
		A Threaded
3"R	DN80R	G Flanged/ Grooved
		A Flanged
3"	DN80	G Flanged/ Grooved
		A Flanged

Size	Pattern	Connection
4"	DN100	G Flanged/ Grooved
		A Flanged
6"	DN150	G Flanged/ Grooved
		A Flanged
8"	DN200	G Flanged/ Grooved
		A Flanged
10"	DN250	G Flanged/ Grooved



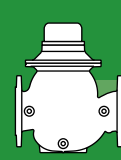

Flow Control & Pressure Reducing Hydrometer, 2-Way

Magnetic (M0) Drive with Manual Selector, Plastic Pilot and Accessories (K)

IR-972-M0-KVZ

Size	Pattern	Connection
1½"	DN40	G Threaded
2"	DN50	G Threaded
		G Flanged
	A	Threaded
2½"	DN65	G Flanged
3"R	DN80R	G Threaded

Size	Pattern	Connection
3"R	DN80R	G Flanged
3"	DN80	G Flanged/ Grooved
		A Flanged
4"	DN100	G Flanged/ Grooved
		A Flanged



Additional Features & Options - Suffix Code-K (Plastic) & R (Metal) Accessories

Code	Description
20-3W-P	3W Check Feature (Shuttle Valve) - Plastic
20-2W-M	2W Check Feature - Metal
20-3W-M	3W Check Feature (Shuttle Valve) - 1½"-4" Metal
20-3W-M	3W Check Feature (Shuttle Valve) - 6"-10" Metal
50-3W-P	3W Hydraulic Control (Shuttle Valve) - Plastic
50-2W-P	2W Hydraulic Control (2-Way Hydraulic Relay) - Plastic
50-3W-M	3W Hydraulic Control (Shuttle Valve) - Metal
50-2W-M	¾" 2-Way Hydraulic Relay (2W-HRV) - Brass
54-3W-P	1½" 3-Way Hydraulic Relay (3W-HRV) - Plastic
55-P	Solenoid Controlled - Plastic
55-M	Solenoid Controlled - 1½"-4" - Metal
55-M	Solenoid Controlled - 6"-10" - Metal
Z	Manual Selector - 1½"-4"
Z	Manual Selector - 6"-10"
HP	Metal Primary Gear Cover
Sx	Pulses Divider to adjust pulse rate for controllers having a slow scanning rate
RP	Reed-switch Electric Pulse Transmitter (for Magnetic Register)
R	Metal Tubing & Fittings (add to plastic standard) -1½"-3"R
R	Metal Tubing & Fittings (add to plastic standard) -3"-4"
S	Pump Shut-off Switch Assembly (for AMV only)

BERMAD Irrigation

Hydrometer & Auto Metering Valves 1½" - 10"

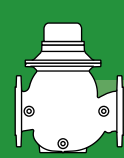
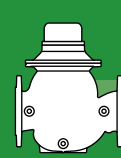

Table of Contents

900 Series





Packing Specifications

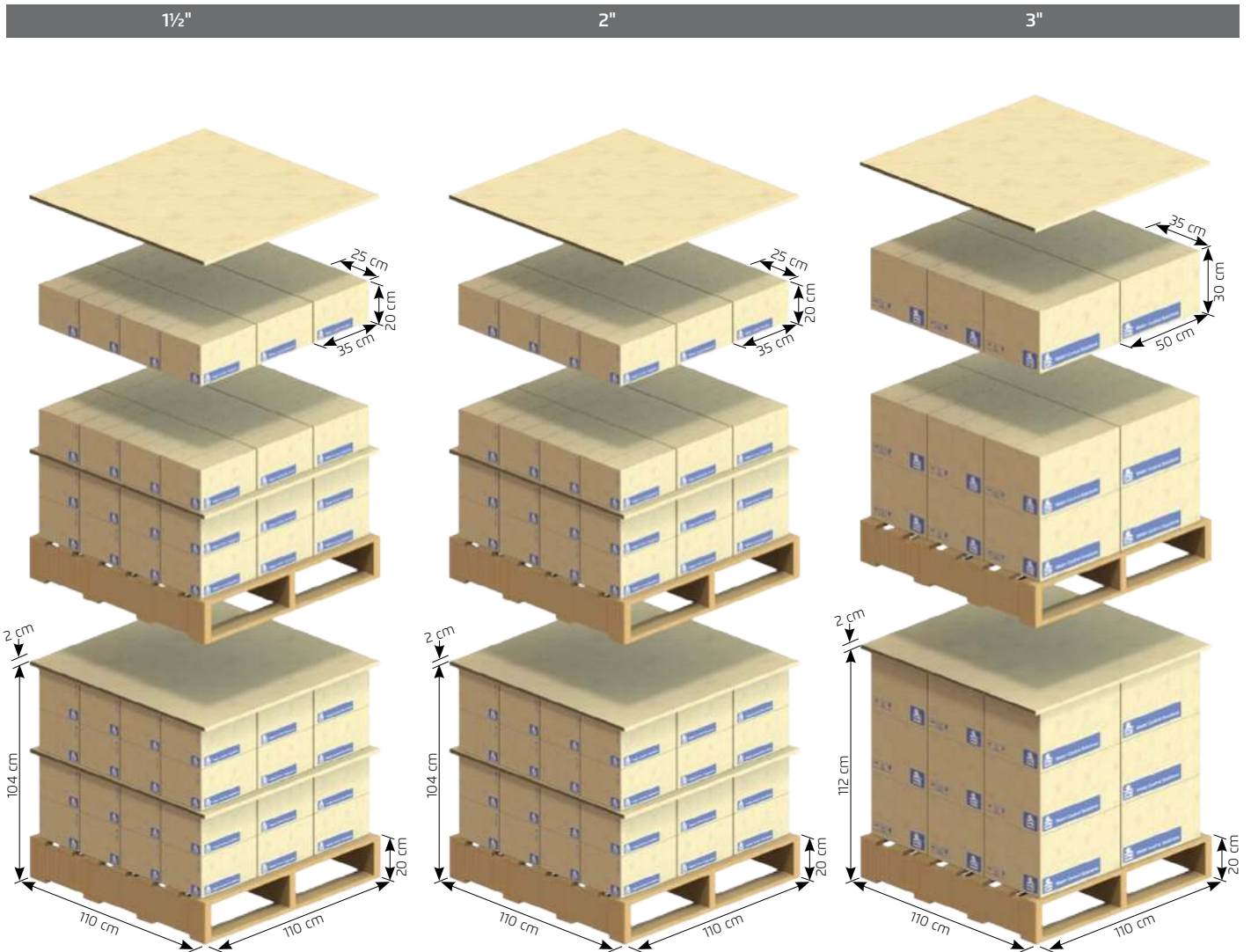

Per Box

Valve Size	Box					
	Units	Length [cm]	Width [cm]	Height [cm]	Weight [kg]	Volume [m ³]
1 1/2"	1	35	25	20	7.4	0.02
2"	1	35	25	20	7.6	0.02
3" Flanged	1	50	35	30	23.72	0.05

Per Pallet

Valve Size	Pallet							
	Number of Boxes	Number of Levels	Number of Units	Length [cm]	Width [cm]	Height [cm]	Gross Weight [kg]	Volume [m ³]
1 1/2"	48	4	48	110	110	104	376	1.3
2"	48	4	48	110	110	104	385	1.3
3" Flanged	18	3	18	110	110	112	447	1.3

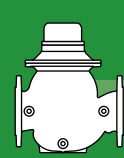

Packing Specifications

4"

6"

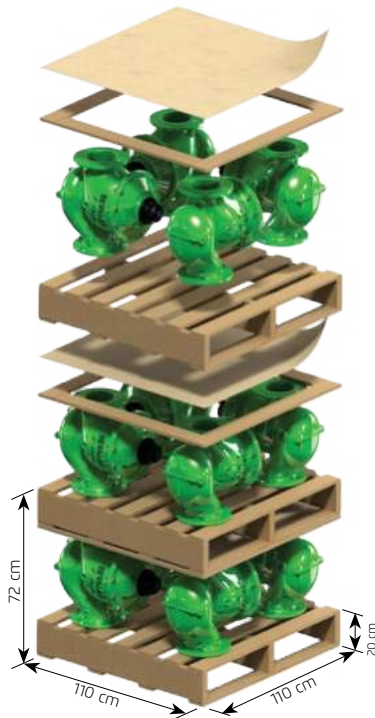
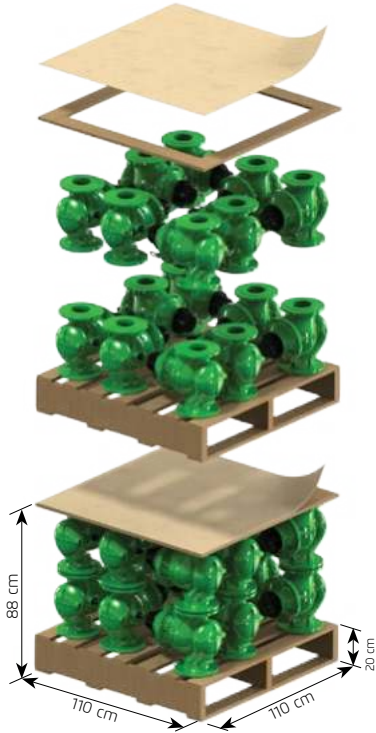

4"	
No. of Layers	2
No. of Units	16
Length [cm]	110
Width [cm]	110
Height [cm]	88
Gross Weight	500
Volume [m ³]	1.06

6"	
No. of Layers	1
No. of Units	4
Length [cm]	110
Width [cm]	110
Height [cm]	72
Gross Weight	300
Volume [m ³]	0.87

8"

10"

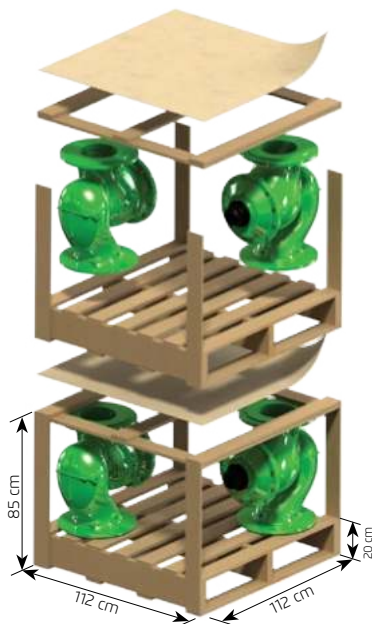
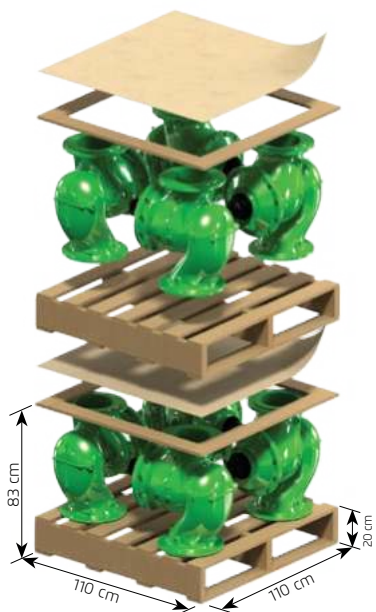

8"	
No. of Layers	1
No. of Units	4
Length [cm]	110
Width [cm]	110
Height [cm]	83
Gross Weight	388
Volume [m ³]	1.00

10"	
No. of Layers	1
No. of Units	2
Length [cm]	112
Width [cm]	112
Height [cm]	85
Gross Weight	300
Volume [m ³]	1.07



TURBO-IR-M

Water Meter with Magnetic Register

The TURBO-IR-E uses a multi-blade plastic paddle mounted at the top of the water passage, where disturbance from solids suspended in the water is minimal, permitting accuracy of metering in water containing up to 30% solid debris.

Ideal for irrigation and wastewater applications.

Features and Benefits

- Magnetic drive
- Dry, vacuum sealed register
- Option for "reed switch" sensor
- Paddle wheel design prevents jamming and damage due to solid debris
- Easy maintenance
- Low head loss

Typical Applications

- Computerized Irrigation Systems
 - Irrigation Control Head
 - In-Field Control Head
- Remote Flow Data Read-Out
 - Flow Monitoring & Leakage Control
 - Water Treatment Systems
 - Volumetric Irrigation Systems



Dimensions and Weights

Nominal Size	mm	50	65	80	100	125	150	200	250	300
	Inch	2"	2½"	3"	4"	5"	6"	8"	10"	12"
L, Length (mm)		200	200	225	250	250	300	350	450	500
h, Height (mm)		75	82	95	106	110	135	162	194	220
H, Height (mm)		177	180	185	185	193	198	224	248	274
H1, Height (mm)		247	250	255	255	263	268	294	318	344
W, Width (mm)		125	140	160	180	200	240	295	350	400
Weight (kg)		10.5	11.8	15.5	17.5	19.5	30.5	42.5	60	82.5

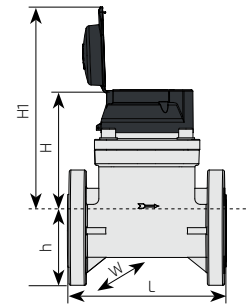

Metrological Data

	Accuracy	DN50	DN65	DN80	DN100	DN125	DN150	DN200	DN250	DN300	
		2"	2½"	3"	4"	5"	6"	8"	10"	12"	
Qmin (Minimum flow), m³/h	±5%	2.8	4	6	10	14	20	36	48	64	
Qt (Transitional flow), m³/h	±2%	10.5	15	22.5	37.5	52.5	75	135	180	240	
Qn (Permanent flow), m³/h	±2%	35	50	75	125	175	250	450	600	800	
Qmax (Peak flow, short time), m³/h	±2%	70	100	150	250	350	500	900	1,200	1,600	
Min reading unit (m³)		0.01	0.01	0.01	0.01	0.01	0.01	0.1	1	1	
Max register capacity (m³)		99,999.999 - 999,999.99 - 9,999,999.9 - 99,999,999									
Kv=Q/√Δp		115	192	219	402	584	1,059	1,826	2,373	4,017	

Turbo-IR-A Flow Chart

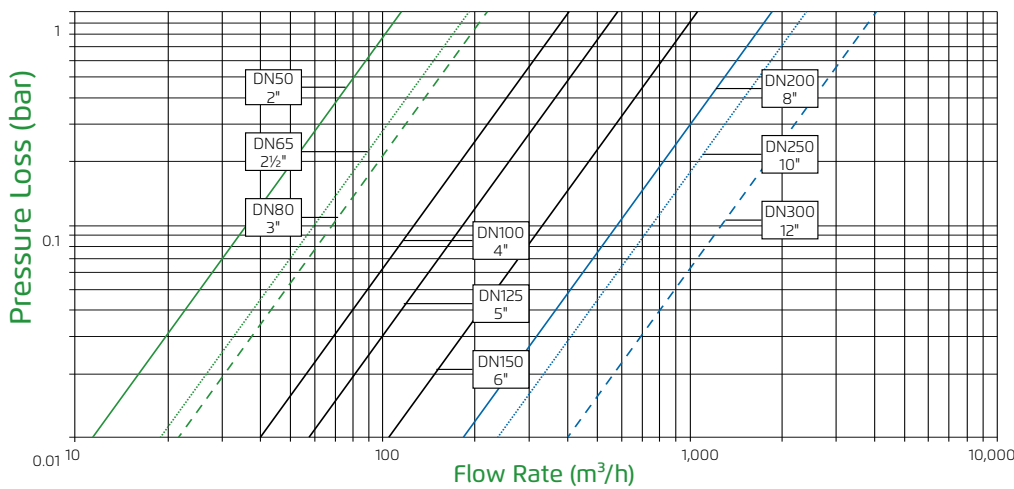

Technical data

- **Body, Cover:** Ductile Iron
- **Coating:** Polyester Green
- **End Connections - Flanged:** ISO PN16, ANSI Class 150
- **Pressure Rating:** ISO PN 16
- **Operating Temperature:** water up to 50°C / 122°F



4" **I** **E** **16** **PB** **M** **S3**

Size	
1½"	DN40
2"	DN50
2½"	DN65
3"	DN80
4"	DN100
5"	DN125
6"	DN150
8"	DN200
10"	DN250
12"	DN300
14"	DN350
16"	DN400
20"	DN500

Turbo-Bar only

Series	Code
Turbo-IR	I
Turbo-BAR WPH	B

Register Type	Code
Magnetic Register	M

Coating	Code
Polyester Blue	PB
Polyester Green	PG

Register Display Units	Code		
Q	Volume		
M³/h	M³		M
GPM	GAL		G

End Connections		Code
ISO-10		10
ISO-16		16
ISO 14		14
ANSI-125		A1
BST-D		BD
AST-D		SD
AST-E		SE
ABNT-10		B1
ABNT-16		B6
JIS-10		J1
JIS-16		J6

Pulse Rate		
Pulse Rate m³		
No Pulse	M-Register	00Y
10 liter	M-Register	0S4
0.1 m³ (100 liter)	M-Register	0S3
1 m³	M-Register	0S2
10 m³	M-Register	0S1
100 m³	M-Register	0S8
1 + 0.1 m³	M-Register	S23
10 + 1 m³	M-Register	S12
100 + 10 m³	M-Register	S81
Pulse Rate Gal		
No Pulse	M-Register	00Y
10 Gal	M-Register	0S3
100 Gal	M-Register	0S2
1,000 Gal	M-Register	0S1
10,000 Gal	M-Register	0S8
100 + 10 Gal	M-Register	S23
1,000 + 100 Gal	M-Register	S12
10,000 + 1,000 Gal	M-Register	S81

Turbo-IR Magnetic Register / Metric Pulses & size Availability				
Size	Pulse per	100 Liter	1m³	10m³
2"-5"; DN50-DN60		Y	Y	N
6"-12"; DN150-DN300		N	Y	Y

Turbo-Bar Magnetic Register / Metric Pulses & size Availability					
Size	Pulse per	100 Liter	1m³	10m³	100m³
1½"-5"; DN40-DN125		Y	Y	N	N
6"-8"; DN150-DN200		N	Y	Y	N
10"-20"; DN250-DN500		N	N	Y	Y

* Consult Bermad For Faster Pulse Rate Please





Turbo-IR-M Paddle Wheel Water Meter

with Magnetic Drive & Magnetic register For Irrigation and Wastewater

Turbo-IR-M

Size	Connection
2"	DN50
2½"	DN65
3"	DN80
4"	DN100
5"	DN125

Size	Connection
6"	DN150
8"	DN200
10"	DN250
12"	DN300



Additional Features & Options

Code	Description
RP	Reed-switch Electric Pulse Transmitter For Turbo-BAR (for Magnetic Register)
Sx	Pulses Divider to adjust pulse rate for controllers having a slow scanning rate

Standard Configuration:

All Water Meters are pre-tested and ready for installation and start-up

Main Body & Cover: Ductile iron body, available to meet international flange standards

Standard Rating: max inlet 16 bar / #150



TURBO-BAR-M

Woltman Water Meter with Magnetic Register

Heavy duty and designed to handle high flow rates, the TURBOBAR WPH-Magnetic Drive water meter covers a very wide flow range, and is particularly suited to industrial, waterworks, water distribution, water monitoring, and agricultural applications.

Based on the Woltmann principle, the helical blades of the turbine rotate around the axis of flow.

TURBOBAR products are long-life, and easy to maintain at low cost.

Features and Benefits

- Removable and interchangeable measuring element
- Dry type register, Hermetically sealed
- Magnetic drive, keeps the register completely separate from water.
- Option for "reed switch" sensor
- Easy maintenance
- Low head loss
- MID 2004/22/EEC Approved, according to OIML R49, EN14154.

Typical Applications

- Computerized Irrigation Systems
 - Irrigation Control Head
 - In-Field Control Head
- Remote Flow Data Read-Out
 - Flow Monitoring & Leakage Control
 - Water Treatment Systems
 - Volumetric Irrigation Systems



Technical Specifications

Turbo Bar Dimensions and Weight Data, mm-kg

Nominal Size	mm	40	50	65	80	100	125	150	200	250	300	400	500
	Inch	1½"	2"	2½"	3"	4"	5"	6"	8"	10"	12"	16"	20"
Flange			ISO, ABNT	ANSI, BSTD, ASTD, JIS									
L, length (mm)	260	200	310	200	225	250	250	300	350	450	500	500	500
H, height (mm)	268	275	270	285	295	304	318	366	393	512	534	669	765
H1, height (mm)	338	345	340	355	365	374	388	436	463	582	604	739	835
h, flange type (mm)	68	75	70	85	95	104	118	135	162	194	216	304	355
h, grooved type (mm)	-	-	-	-	56	60	71	95	-	-	-	-	-
W, flange type (mm)	160	170	160	190	200	230	250	285	340	395	445	600	700
W, grooved type (mm)	-	-	-	-	156	156	156	250	-	-	-	-	-
Weight (kg)	13	12	15	14	16	19	20	39	52	105	120	187	256

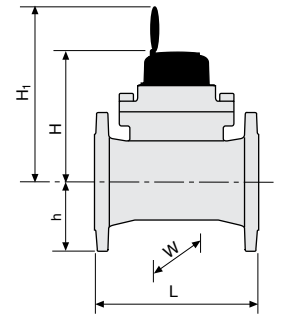

* images are for illustration purpose only

Accuracy Curve

	Accuracy	mm	40	50	65	80	100	125	150	200	250	300	400	500	
		Inch	1½"	2"	2½"	3"	4"	5"	6"	8"	10"	12"	16"	20"	
Qmin (Minimum flow), m³/h	±5%		0.5	0.5	0.8	1.3	1.3	2	3.1	5	8	12.5	32	50	
Qt (Transitional flow), m³/h	±2%		0.8	0.8	1.3	2	2	3.2	5.0	8.0	12.6	20	51	80	
Qn (Permanent flow), m³/h	±2%		25	40	63	63	100	160	250	400	630	1000	1600	2500	
Qmax (Peak flow, short time), m³/h	±2%		31	50	79	79	79	200	313	500	788	1250	2000	3125	
Q2/Q1			1.6	1.6	1.6	1.6	1.6	1.6	1.6	1.6	1.6	1.6	1.6	1.6	
Q3/Q1			50	80	80	50	50	80	80	80	80	80	50	50	
Kv=Q/√Δp			95	125	170	190	280	380	950	1580	2688	4700	9500	15000	
Max. reading, m³			999,999						9,999,999			99,999,999			
Min. reading, liter			1						10			100			
Pressure loss Δp, bar														according to chart	

Flow Curve

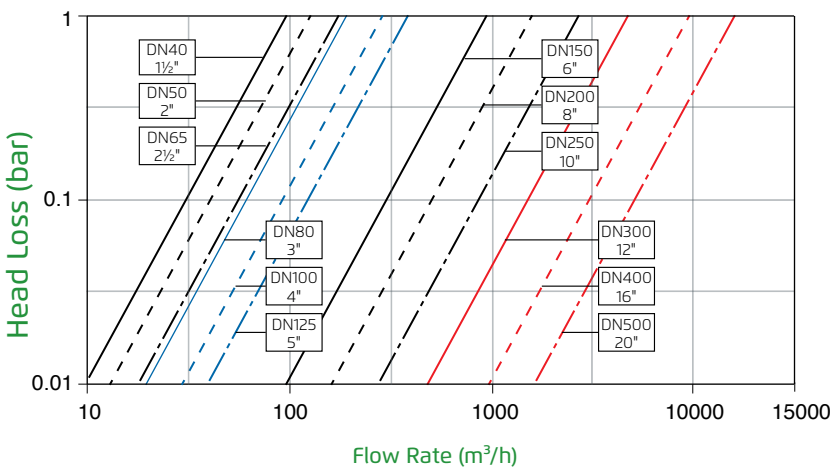

Accuracy Curve

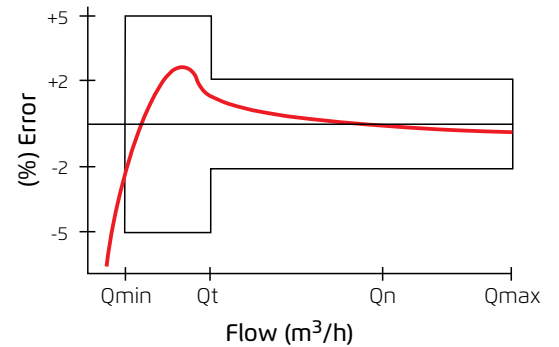

Main Operating Characteristics

- Pressure Rating: PN 16
- Temperature: 50°C





4" → **Size**

Size	Code
1½"	DN40
2"	DN50
2½"	DN65
3"	DN80
4"	DN100
5"	DN125
6"	DN150
8"	DN200
10"	DN250
12"	DN300
14"	DN350
16"	DN400
20"	DN500

I → **Series**

Series	Code
Turbo-IR	I
Turbo-BAR WPH	B

E → **Coating**

Coating	Code
Polyester Blue	PB
Polyester Green	PG

16 → **End Connections**

End Connections	Code
ISO-10	10
ISO-16	16
ISO 14	14
ANSI-125	A1
BST-D	BD
AST-D	SD
AST-E	SE
ABNT-10	B1
ABNT-16	B6
JIS-10	J1
JIS-16	J6

PB → **Coating**

M → **Register Type**

Register Type	Code
Magnetic Register	M

S3 → **Register Display Units**

Register Display Units	Code		
Q	Volume		
M³/h	M³		M
GPM	GAL		G

Pulse Rate

Pulse Rate m³		
No Pulse	M-Register	00Y
10 liter	M-Register	0S4
0.1 m³ (100 liter)	M-Register	0S3
1 m³	M-Register	0S2
10 m³	M-Register	0S1
100 m³	M-Register	0S8
1 + 0.1 m³	M-Register	S23
10 + 1 m³	M-Register	S12
100 + 10 m³	M-Register	S81

Pulse Rate Gal		
No Pulse	M-Register	00Y
10 Gal	M-Register	0S3
100 Gal	M-Register	0S2
1,000 Gal	M-Register	0S1
10,000 Gal	M-Register	0S8
100 + 10 Gal	M-Register	S23
1,000 + 100 Gal	M-Register	S12
10,000 + 1,000 Gal	M-Register	S81

Turbo-IR Magnetic Register / Metric Pulses & size Availability				
Size	Pulse per	100 Liter	1m³	10m³
2"-5"; DN50-DN60		Y	Y	N
6"-12"; DN150-DN300		N	Y	Y

Turbo-Bar Magnetic Register / Metric Pulses & size Availability					
Size	Pulse per	100 Liter	1m³	10m³	100m³
1½"-5"; DN40-DN125		Y	Y	N	N
6"-8"; DN150-DN200		N	Y	Y	N
10"-20"; DN250-DN500		N	N	Y	Y

* Consult Bermad For Faster Pulse Rate Please





Turbo-BAR-M Woltman Water Meter

with Magnetic Drive & Magnetic Register

Turbo-Bar-M

Size	Connection
1½"	DN40
2"	DN50
2½"	DN65
3"	DN80
4"	DN100
5"	DN125
6"	DN150

Size	Connection
8"	DN200
10"	DN250
12"	DN300
14"	DN350
16"	DN400
20"	DN500



Additional Features & Options

Code	Description
RP	Reed-switch Electric Pulse Transmitter For Turbo-BAR (for Magnetic Register)
Sx	Pulses Divider to adjust pulse rate for controllers having a slow scanning rate

Standard Configuration:

All Water Meters are pre-tested and ready for installation and start-up

Main Body & Cover: Ductile iron body, available to meet international flange standards

Standard Rating: max inlet 16 bar / #150



Electromagnetic Water Meter by Euromag

Models: MUT2200EL, MUT2300, MUT1100J & MUT1222

The BERMAD Euromag MagMeter is a robust state of the art meter for the Ag applications industry. This meter technology can detect flows as low as 0,13 m³/h with 0.2% accuracy. Providing unparalleled accuracy and reliability at all flow ranges.

BERMAD Euromag meters are the industry leader for water measurement and accumulation reporting.

BERMAD Euromag MagMeters available in diameter range of 1½" - 104".



Features and Benefits

- **High Accuracy at wide flow range** – Each sensor is calibrated on a hydraulic bench equipped with a reference weighting system
- **Open flow path** – Allows for use upstream of filtration, in canals and effluent Water
- **DC compact electronics** – Low power consumption ideal for use in locations without power supply
- **Rugged and Efficient Construction** – Accurate measurement of corrosive fluids, manure and wastewater
- **Combined Sensors** – Flow and pressure transducer Combined in one unit for optimizing monitoring capabilities

Typical Applications

- Compliant with water usage reporting regulation
- Remote or local monitoring of flows and water usage
- Leak and plugging detection in irrigation systems
- Accumulations of filtration flush water



Technical Specifications

- **Flow tube material:** AISI 304, AISI 316
- **Flange material:** Coated Carbon steel, AISI 304, AISI 316
- **Electrodes material:** Hastelloy C, AIS
- **Internal lining:**
 - PTFE Standard
 - Ebonite (Hard Rubber)
 - Liquid temperature: 80°C
- **Available Sizes:**
 - **MUT2200:** ½"-104"
 - **MUT2300:** 2"-12"
 - **MUT1100J:** 1½"-6"
 - **MUT1222:** ½"-104"
- **Flange Standard:** EN1092-1, ANSI 150, ANSI 300, ANSI 600, DIN 2501, BS 4504, AS 2129 (TABLE D - E - F), AS 4087, ISO 7005-1, KS 10K
- **Isolation Rating:**
 - **MUT2200:** IP68 1,5 m continuous immersion (EN 60529)
 - **MUT2300:** IP68 1,5 m continuous immersion (EN 60529)
 - **MUT1100J:** IP67 (IP68 on request)
 - **MUT1222:** IP68 1,5 m continuous immersion (EN 60529)
- **Compatible Converters:** MC406, MC608 A/B/R/P/I
- **Electrical Connections:** Cable glands M20 x 1.5, terminal blocks and sealing resin
- **Calibration:** ISO 11631 Group B1
 - Measurement error 0.2% +/- 2 mm/s When installed as described below.
 - Repeatability 0.1%

Converter MC406

The MC406 is the new high-efficiency, technologically advanced battery powered electronic converter from Euromag, combining high performances and dedicated applications solutions to a low cost of ownership.

Up to 10 years of battery life allows maintenance free of operation.

Battery pack is then easily replaceable, all data are automatically stored in the internal EEPROM memory and no data will be lost.



Converter MC608

The MC608 converter has been designed with the purpose of meeting all the requirements of modern water management systems through a flexible and hybrid electronic, mains powered, battery powered, or both.



Remote Installation (optional)

Separate (Remote) installation is optional, extension cable with variable length supplied from factory



Remote data reading

With advanced display information, on-site data collection and remote monitoring, the MC406 and MC 608 allow any customer to access all the information, easily and at no cost.

Add on modules of temperature and pressure reading, make the MC406 one of the most complete electronic converter for electromagnetic flowmeters available, giving to the end user a full control over all the main parameters of its network, reducing cost of programming, installation and maintenance.

One unit supplying flow - pressure - temperature, all at the same time.



MC406 Dimensions

MUT2200EL - MC406 VERTICAL

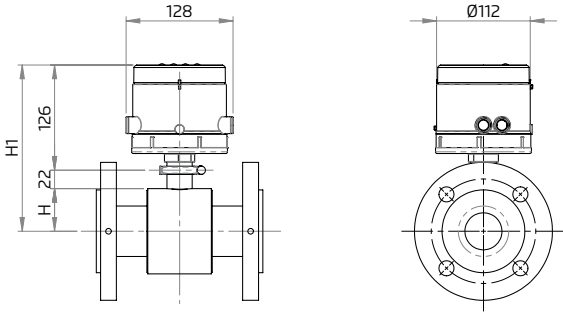

Size	H (mm)	H1 (mm)
1½"; DN40	44	192
2"; DN50	51	199
3"; DN80	64	212
4"; DN100	81	229
6"; DN150	105	253
8"; DN200	131	279
10"; DN250	160	308
12"; DN300	186	334
14"; DN350	202	350
16"; DN400	228	376
18"; DN450	260	408
20"; DN500	285	433
24"; DN600	342	490

MUT2300 - MC406 VERTICAL

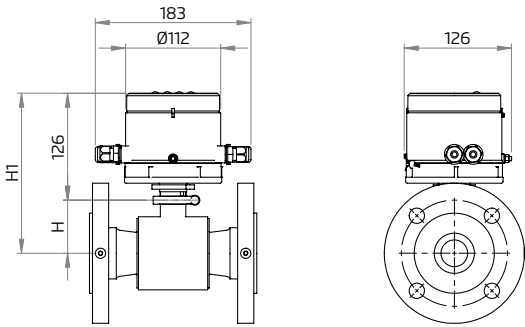

Size	H (mm)	H1 (mm)
2"; DN50	62	188
3"; DN80	71	197
4"; DN100	79	205
6"; DN150	101	227
8"; DN200	147	273
10"; DN250	176	302
12"; DN300	207	333

MUT1100J - MC406 VERTICAL

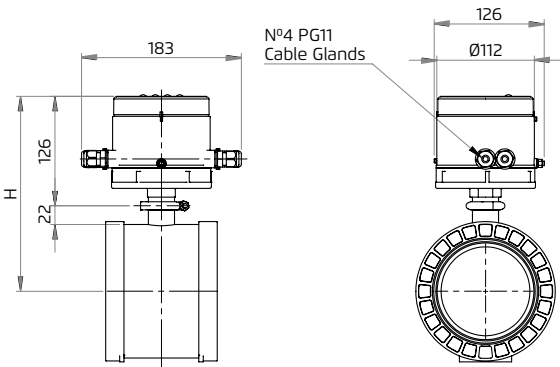

Size	H (mm)
1½"; DN40	187
2"; DN50	196
2½"; DN65	205
3"; DN80	211
4"; DN100	224
6"; DN150	254

MUT1222 - MC406 VERTICAL

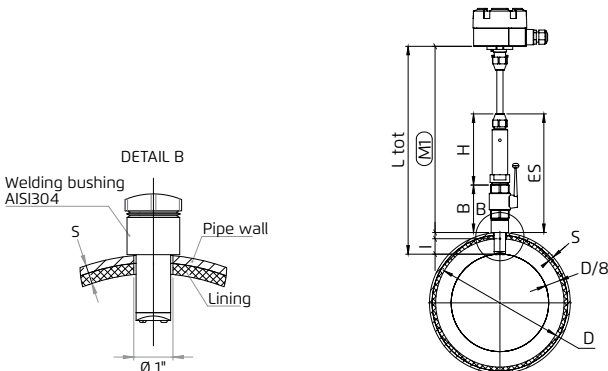

Size	L total	ES
Small	403	230
Medium	674	367
Large	916	499



Required Upstream and Downstream Pipe Lengths

MUT 1222:

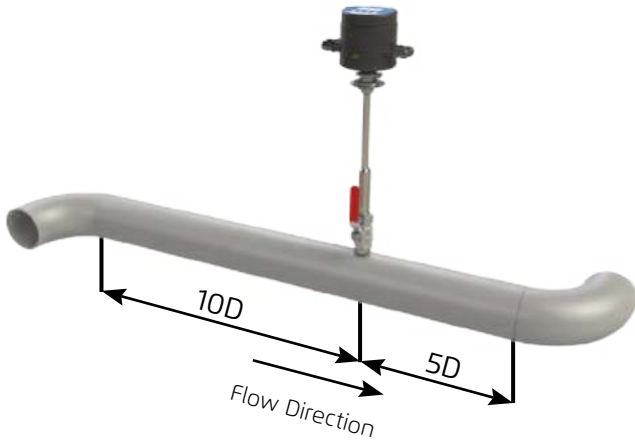

MUT 1100J:

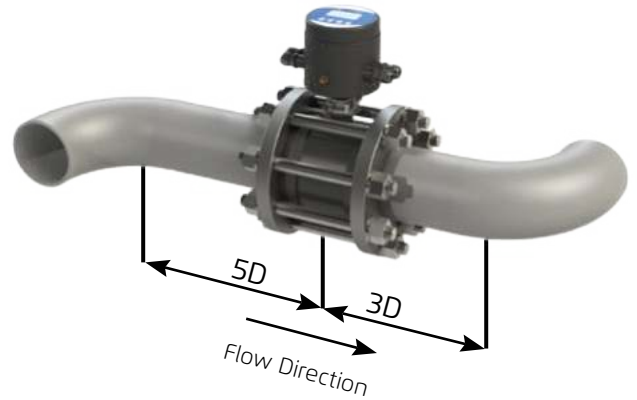

MUT 2200EL:

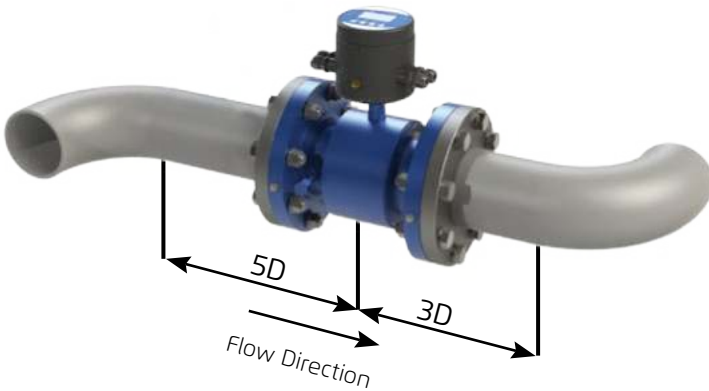

MUT 2300

No Upstream and Downstream Required Distances

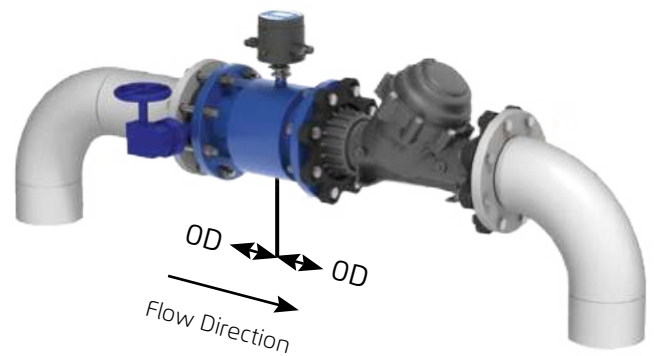

Grounding Rod:





Electromagnetic Flow Meter - MUT2200EL

with MC406 converter

MUT2200EL

Size		Installation
2"	DN50	Compact
3"	DN80	Compact
4"	DN100	Compact
6"	DN150	Compact
8"	DN200	Compact

Size		Installation
10"	DN250	Compact
12"	DN300	Compact
14"	DN350	Compact
16"	DN400	Compact



New

Electromagnetic Flow Meter - MUT2300

with MC406 converter

MUT2300

Size		Installation
2"	DN50	Compact
3"	DN80	Compact
4"	DN100	Compact
6"	DN150	Compact

Size		Installation
8"	DN200	Compact
10"	DN250	Compact
12"	DN300	Compact



New

Electromagnetic Flow Meter - MUT1100J

with MC406 converter

MUT1100J

Size		Installation
1½"	DN40	Compact
2"	DN50	Compact
3"	DN80	Compact

Size		Installation
4"	DN100	Compact
6"	DN150	Compact



New



Electromagnetic Flow Meter - MUT1222

MUT1222

Size		Installation
2"-24"	DN50- DN600	Compact

Size		Installation
8"-60"	DN200- DN1500	Compact
18"-104"	DN450- DN2600	Compact



New

A Pair of Grounding Rings

wms28

Size	
1½"	DN40
2"	DN50
3"	DN80
4"	DN100

Size	
5"	DN125
6"	DN150
8"	DN200
10"	DN250
12"	DN300

- Separate installation Cable cost: \$7 per meter
- Standard Configuration
- MUT2200/2300 do not include grounding rings
- MC406 is battery powered converte
- Additional sizes are available, please contact Bermad for additional information and pricing



NEW



C15

Air Valve Series

BERMAD's new advanced line of Air Valves joins its extensive line of hydraulic control valves to create comprehensive control solutions for pressurized pipelines and networks. System engineers and end-users can now design and install far more optimized solutions for their system requirements.

The new line of BERMAD Air Valves includes Plastic Air Valves and Metal Air Valves for a variety of water pipelines and networks offering.

Features and Benefits

- Higher flow rates
- Low pressure sealing
- Minimal spray effect
- Built-in surge protection (anti-slam feature)
- Versatile design for easy installation
- Reliable structure

Typical Applications

- Main Irrigation Networks: Protection against air accumulation and vacuum formation downstream of pumps, along supply lines and at elevations in main irrigation networks.
- Irrigation Control Heads: Protection against air accumulation and vacuum formation at filtration and fertilization stations and downstream of main control valves.
- Infield Systems: Protection against air accumulation and vacuum formation in proximity to water meters and automatic regulators.
- Landscape Irrigation: Protection against air accumulation and vacuum formation.
- Pumping stations: Maximizing pumping efficiency, priming capabilities and reducing the possibility of pressure surges during power failure modes.



Automatic Air Valves – A10, A30

- Body material – Glass-reinforced Polyamide
- Inlet sizes – DN20 – DN25; ¾" – 1"
- Connections – Threaded Male BSPT / NPT
- Outlet – Sideways
- Pressure rating – ISO PN10/16, ANSI 150/230
- Operating pressure range: 0.1 – 10/16 bar, 1.5 – 150/230 psi (A10/A30)
- Operating temperature: Water up to 60°C
- Benefits – effective automatic air release, low pressure sealing



Kinetic (Air / Vacuum) Air Valves – K10

- Body material – Glass-reinforced Polyamide
- Inlet sizes – DN20 – DN50; ¾" – 2"
- Connections – Threaded Male ¾", 1" BSPT / NPT
Threaded Female 2" BSPT / NPT
- Outlet – Sideways
- Pressure rating – ISO PN10, ANSI 150
- Operating pressure range: 0.1 – 10bar, 1.5 – 150psi
- Operating temperature: Water up to 60°C
- Benefits – effective air relief and intake, low pressure sealing



Combination Air Valves - C10, C30

- Body material – Glass-reinforced Polyamide
- Inlet sizes – DN20-DN80; ¾"-3"
- Connections – Threaded Male BSPT / NPT, Flange 2", 3"
- Outlet – Sideways, for inlet DN50-80; 2-3" the outlet is DN50; 2" female threaded.
- Pressure rating – ISO PN10/16, ANSI 150
- Operating pressure range: 0.1 – 10/16 bar, 1.5 – 150/230 psi
- Operating temperature: Water up to 60°C
- Benefits – higher air flow during air relief and intake, effective automatic air release, low pressure sealing



COMBINATION AIR VALVE Model C15, C35

- Body – Glass-reinforced Nylon
- Inlet sizes: DN50; 2"
- Connections: Threaded male
- Outlet – Sideways, DN40; 1½" female threaded
- Pressure rating – ISO PN10/16, ANSI 150/230
- Operating pressure range: 0.1 – 10/16 bar, 1.5 – 150/230 psi
- Operating temperature: Water up to 60°C
- Benefits – Field proven designed for use in irrigation applications with water quality such as river water, channel water, dam water or treated effluent with high reliability



Metal Combination Air Valves – C70, C75

- Body Material and coating – cast ductile Iron, baked Polyester Green
- Inlet sizes: DN50 - DN300; 2" – 12"
- Connections – Threaded Female (DN50; 2"), Flanged
- Outlets – Sideways, downwards, mushroom configuration
- Benefits – Higher air flow during air relief and intake, effective automatic air release, low pressure sealing, minimal spray effect during air release, built-in surge protection (anti-slam feature), easy installation



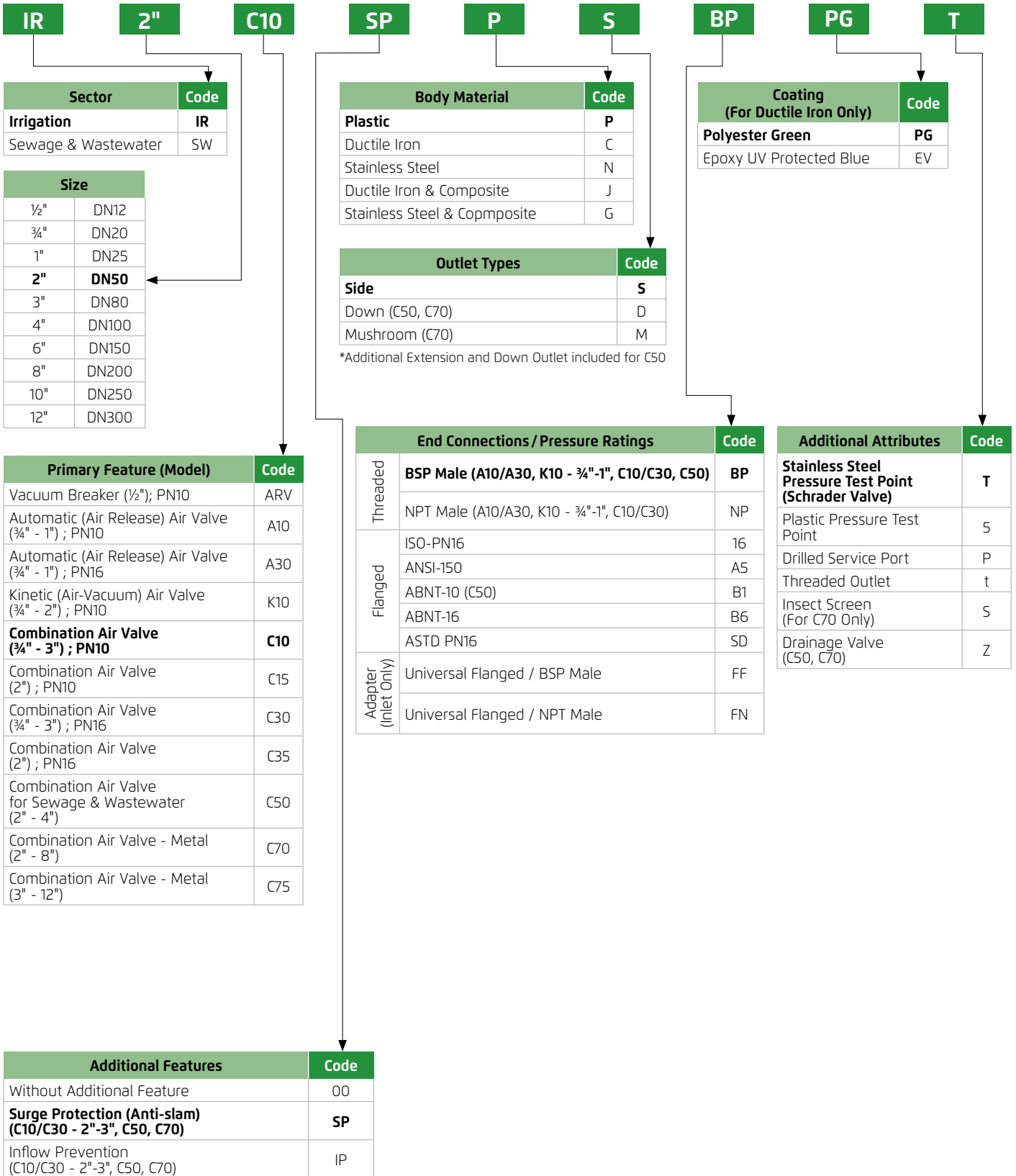



Combination Air Valve

PN10 (0.1 - 10 bar)

IR-C10-P

Size	Connection	Additional Features
¾"	DN20 Threaded	---
1"	DN25 Threaded	---
2"	DN50 Threaded	---
	DN50 Flanged	---
3"	DN80 Flanged	---



Combination Air Valve

PN10 (0.1 - 10 bar)

IR-C15-P

Size	Connection	Additional Features
2"	DN50 Threaded	---

New



Kinetic Air Valve

PN10 (0.1 - 10 bar)

IR-K10-P

Size	Connection	Additional Features
¾"	DN20 Threaded	---
1"	DN25 Threaded	---
2"	DN50 Threaded	---



Automatic Air Valve

PN10 (0.1 - 10 bar)

IR-A10-P

Size	Connection	Additional Features
¾"	DN20 Threaded	---
1"	DN25 Threaded	---





Combination Air Valve

PN16 (0.1 - 16 bar)

IR-C30-P

Size	Connection	Additional Features
3/4"	DN20	Threaded
1"	DN25	Threaded
2"	DN50	Threaded
		Flanged
3"	DN80	Flanged



Combination Air Valve

PN16 (0.1 - 16 bar)

IR-C35-P

Size	Connection	Additional Features
2"	DN50	Threaded

New



Combination Air Valve

PN16 (0.1 - 16 bar)

IR-C30-C

Size	Connection	Additional Features
1"	DN25	Threaded
2"	DN50	Threaded
		Flanged



Automatic Air Valve

PN16 (0.1 - 16 bar)

IR-A30-P

Size	Connection	Additional Features
3/4"	DN20	Threaded
1"	DN25	Threaded





Vacuum Breaker, PN10

(0.2 - 10 bar)

IR-ARV-P

Size	Connection	Additional Features
½"	DN12	Threaded
		Vacuum Breaker ½"



Combination Air Valve

PN16 (0.1 - 16 bar)

IR-C70-J-C

Size	Connection	Additional Features
2"	DN50	Threaded
		Flanged
3"	DN80	Flanged
		Flanged
4"	DN100	Flanged
		Flanged
6"	DN150	Flanged
		Flanged
8"	DN200	Flanged
		Flanged
10"	DN250	Flanged
		Flanged



Combination Air Valve

PN16 (0.1 - 16 bar)

IR-C75-J-C

Size	Connection	Additional Features
3"	DN80	Flanged
		Flanged
4"	DN100	Flanged
		Flanged
6"	DN150	Flanged
		Flanged
8"	DN200	Flanged
		Flanged
10"	DN250	Flanged
		Flanged
12"	DN300	Flanged
		Flanged





Combination Air Valve for Sewage & Wastewater

PN10 (0.1 - 10 bar)

IR-C50-P

Size		Connection	Additional Features
2"	DN50	Threaded	---
		Flanged	---
3"	DN80	Threaded	---
		Flanged	---
4"	DN100	Flanged	---



Combination Air Valve for Sewage & Wastewater

Ductile Iron Body and Plastic / Ductile Iron Cover, PN16 (operating pressure 0.1 - 10 bar).

IR-C-50-J-C

Size		Connection	Additional Features
2"	DN50	Threaded	---
		Flanged	---
3"	DN80	Flanged	---
4"	DN100	Flanged	---

New



Combination Air Valve for Sewage & Wastewater

Stainless Steel Body with Plastic / Stainless Steel Cover; PN16 (operating pressure 0.1 - 10 bar)

IR-C50-G-N

Size		Connection	Additional Features
2"	DN50	Threaded	---
		Flanged	---
3"	DN80	Threaded	---
		Flanged	---





Additional Features & Add-ons

Code	Description	Compatible with Models
Drainage Valve (Z)	1" Plastic Drainage Valve	C50-P
	1" Stainless Steel Drainage Valve	C50-C/J/G/N
	¾" Drainage Valve	C70, C75
Flange - Plastic	ISO16 / ANSI150 Plastic Flange, connected to male thread	C10, C30
		C50
Flange - Metal	ISO16 / ANSI150 Metal Flange, connected to male thread	C10, C30
Inflow Prevention (IP)	Inflow Prevention device connected to the valve outlet	C10, C30, C50
Insects Screen (S)	Stainless Steel Insect Screen	C70, C75
Service Port (P)	Drilled Service Port, ⅛" for ¾-1" (DN20, DN25) inlet and ¼" for 2-3" (DN50, DN80) inlet with Plastic Plug	A10, A30, C10, C15, C30, C35
	Drilled Lower Service Port, ¼" NPT with Stainless Steel plug	C70, C75
Service Port (U)	Drilled Upper Service Port, ½" NPT with Stainless Steel plug	C70, C75
Surge Protection (SP)	Surge Protection device connected to the valve outlet	C10, C30, C50
Test Point (T)	Stainless Steel Pressure Test point (Schrader Valve)	A10, A30, C10, C15, C30, C35
Threaded outlet (t)	¾" (DN20) Female threaded outlet	A10, A30, C10, C30



Packing Specifications

K10



¾" - 1"	
No. of Layers	2
No. of Units	24
Length [cm]	31.0
Width [cm]	23.0
Height [cm]	24.5
Gross Weight	4.82
Volume [m ³]	0.02

**C10
C30**



¾" - 1"	
No. of Layers	1
No. of Units	12
Length [cm]	37.0
Width [cm]	27.2
Height [cm]	17.5
Gross Weight	5.84
Volume [m ³]	0.03

**A10
A30**



¾" - 1"	
No. of Layers	1
No. of Units	12
Length [cm]	37.0
Width [cm]	27.2
Height [cm]	17.5
Gross Weight	4.88
Volume [m ³]	0.03

K10



2"	
No. of Layers	1
No. of Units	12
Length [cm]	37.0
Width [cm]	27.2
Height [cm]	17.5
Gross Weight	3.92
Volume [m ³]	0.03

**C15
C35**



2"	
No. of Layers	1
No. of Units	9
Length [cm]	31.7
Width [cm]	27.5
Height [cm]	19.1
Gross Weight [kg]	0.61
Volume [m ³]	0.02

**C10
C30**



2"	
No. of Layers	1
No. of Units	6
Length [cm]	40.5
Width [cm]	25.5
Height [cm]	28.2
Gross Weight	8.47
Volume [m ³]	0.03



Packing Specifications

K10 - 3/4", 1"

K10 - 2"
C10, A10, 3/4", 1"

C10 - 2"
C30 - 2"

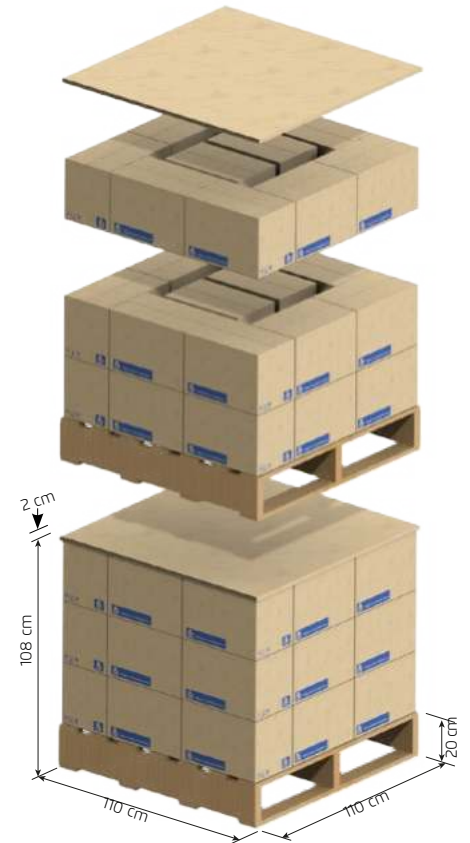
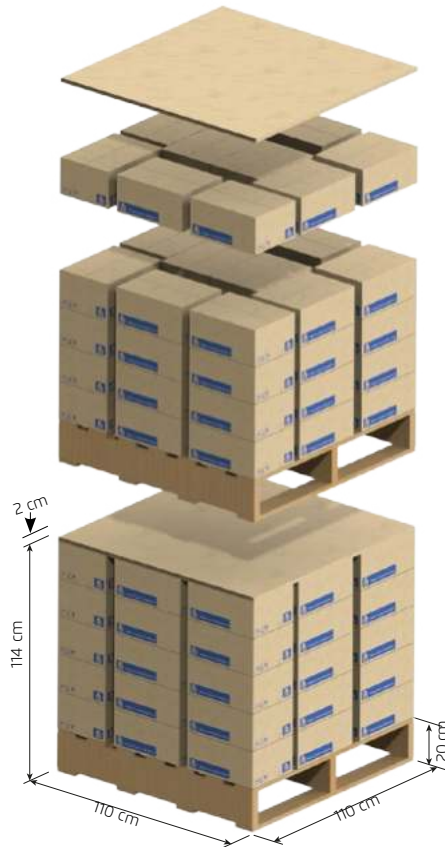
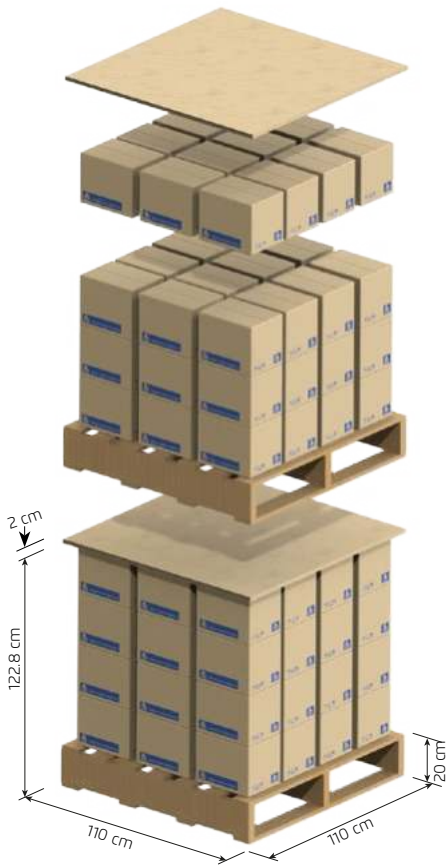

Per Pallet

Valve Size	Pallet							
	Number of Boxes	Number of Levels	Number of Units	Length [cm]	Width [cm]	Height [cm]	Gross weight [kg]	Volume [m ³]
3/4", 1" K10	48	4	1,152	110	110	122.8	251	1.49
3/4", 1" C10 / C30	50	5	600	110	110	114	312	1.38
3/4", 1" A10 / A30	50	5	600	110	110	114	264	1.38
2" K10	50	5	600	110	110	114	216	1.38
2" C10 / C30	30	3	180	110	110	108	274	1.31
2" C15 / C35	40	5	360	110	110	125	250	1.52



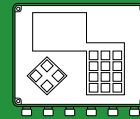

IR-BIC Series

BERMAD's line of irrigation controllers provides a wide range of monitoring, control and analysis solutions for a wide range of irrigation applications.

The BERMAD BIC Series allows for healthier plants and better yields, through the use of efficient management tools for applying nutrients and water to where they are needed most.

The BIC Series gives the user the management tools for efficient use of resources such as water, energy, chemicals, and manpower and is cost effective.

Typical Applications

- Reservoir management
- Pump stations control
- Filter stations
- Water and pressure monitoring
- Chemical injection
- Emission devices control
- Environmental monitoring
- Irrigation control

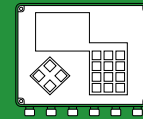

Features and Benefits

- **Modular Hardware:**
 - Local DC or AC outputs and digital inputs
 - Single Cable, Two-Wire
 - Radio
 - Weather monitoring and evapotranspiration control
 - pH/EC monitoring and control
 - Analog inputs
- **Irrigation:**
 - Multiple irrigation programs and fields including pumps, filters, chemical injectors, and valves can be define in a single controller
 - Water dosage by time, volume, volume per area, and evapotranspiration
 - Irrigation by days of the week or cycle of days
 - Single cycle or pulse irrigation
 - Start by time, manually, and/or physical or environmental conditions
 - Each program allows the control of single valve, sequence of valves and/or groups of valves
- Hydraulic considerations for system protection
- Managing multiple water sources including pump stations with multiple pumps in each location, storage tanks and reservoirs
- **Chemical injection:**
 - Local and multiline (central) injection sites.
 - Chemical dosage modes:
 - Continuous
 - Concentration
 - Proportional
 - Three stage injection: Pre-water, injection, post water
- **Filtration management:**
 - Local and multiline filter stations sites
 - Flush by time, pressure differential (PD), or both time and PD
 - Adjustable parameters
 - "Endless looping" detection and prevention
 - Accumulation of flush cycles by time, PD, and manual
- **Alarms:**
 - High flow, low flow, leaks, pipe breaks, low pressure
 - Chemical leakage, injector malfunction
 - PD sensor failure
 - Low battery, no AC power (For AC controllers)
- **Internet Communication Channels:**
 - USB or GSM modem operating on most common cellular networks
 - Ethernet cable
 - E-mail notifications sent directly from local controller to assigned subscriber
- **General:**
 - Multi language controller
 - Large graphic LCD and full numeric keyboard
 - Multi-level programing to fit User Interface (UI) to specific application and user
 - Conditions system allows start, stop, enable or disable programs
 - Detailed event log for all system events

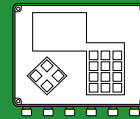

Primary Features	Secondary Features	Accessories	Uniliner		100	
			RF	Two-wire	BIC 100	
Form of irrigation	Time				✓	
	Volume					
	SMART Control	Weather Station				
		Sensor			✓	
		Flow/pressure Monitoring				
		ET				
	Volume/Area (In/Sqr Ft)					
Output type (Valves, pumps, etc.)	AC				✓	
	DC (Latch)	Radio	✓			
		Two-Wire		✓		
		Controller Direct			✓	
DC (Continuous)						
Input type (Sensors, water meter, etc.)	Local	Dry Contact			✓	
		Analog				
	Remote	Dry Contact	✓	✓		
		Analog				
Power source	110VAC / 220VAC		✓	✓	✓	
	Solar + battery		✓	✓	✓	
	Batteries (D Size)				✓	
Central Control			✓	✓		
Communication	Cellular					
	Radio					
Number of outputs			8-32	8-32	2-10	
Number of digital inputs			8-16	8-16	3	

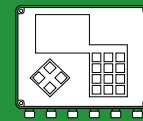

BIC 1000				BIC 1500			BIC 2500		
DC	AC	RF	2W	AC	DC	RF	AC/DC	RF	Two-wire
✓	✓	✓	✓		✓	✓	✓	✓	✓
					✓	✓	✓	✓	✓
					✓	✓	✓	✓	✓
✓	✓	✓	✓		✓	✓	✓	✓	✓
					✓	✓	✓	✓	✓
					✓	✓	✓	✓	✓
					✓	✓	✓	✓	✓
	✓	✓	✓				✓	✓	✓
✓		✓				✓		✓	
			✓						✓
✓					✓		✓	✓	✓
✓	✓								
✓	✓	✓	✓		✓		✓	✓	✓
					✓		✓	✓	✓
		✓	✓			✓	✓	✓	✓
						✓	✓	✓	✓
	✓	✓	✓		✓		✓	✓	✓
✓					✓	✓	✓	✓	✓
						✓			
					✓	✓	✓	✓	✓
	✓				✓	✓	✓	✓	✓
✓		✓			✓	✓	✓	✓	✓
12-32	12-36	12-32	12-32		4-16	0-32	16-1000	16-1000	16-1000
4	4	4	4		8	0-23	8-1000	8-1000	8-1000

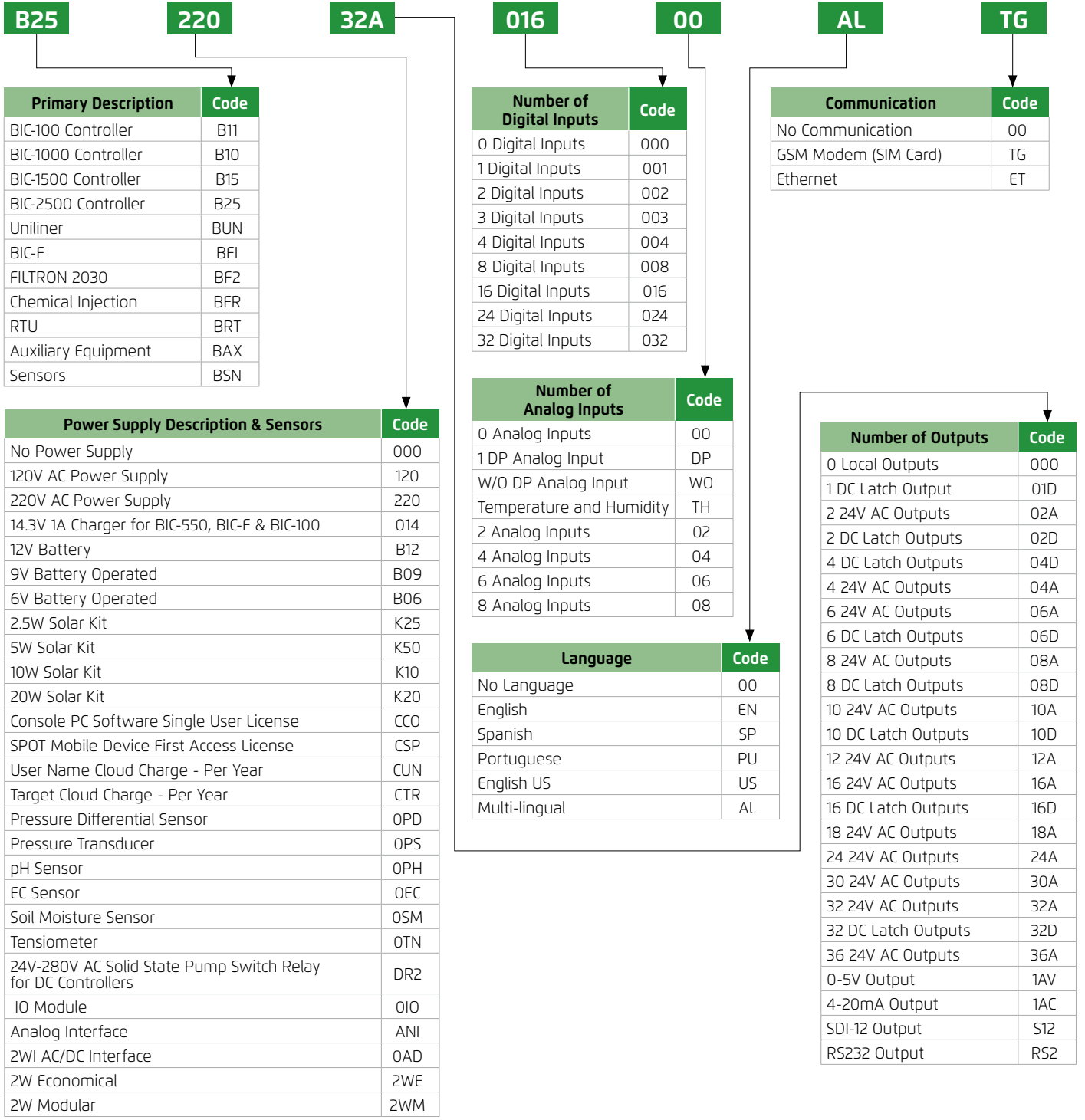
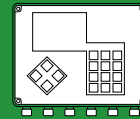

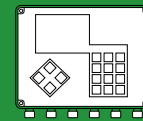

R45

2WI

WEI

2WA

Additional Feature 1	Code
Z-Wire Interface	2WI
RADIO G5	RG5
RADIO G5H	G5H
RADIO G5L	G5L
Radio G 4.5	R45
External Antenna Radio G 4.5	E45
Radio G 4	R40
Radio Analog Interface	RFA
Radio Interface Without Master	RFI
Ec/Ph Interface	EPI
Smart Pump	FSP
Platform	FPL
Weather Station	WEI
Z-Wire Analog Interface	2WA
Local Temperature And Humidity	LTH
Radio Temperature And Humidity	RTH
Radio Analog Interface	RFA
Z-Wire Analog Interface	2WA
Z-Wire Parts	ZWP

Additional Feature 3	Code
Z-Wire Interface	2WI
RADIO G5	RG5
RADIO G5H	G5H
RADIO G5L	G5L
Radio G 4.5	R45
External Antenna Radio G 4.5	E45
Radio G 4	R40
Radio Analog Interface	RFA
Radio Interface w/out Master	RFI
EC/Ph Interface	EPI
Smart Pump	FSP
Platform	FPL
Weather Station	WEI
Z-Wire Analog Interface	2WA
Local Temperature & Humidity	LTH
Radio Temperature & Humidity	RTH
Radio Analog Interface	RFA
Z-Wire Analog Interface	2WA
Z-Wire Parts	ZWP

Additional Feature 2	Code
Z-Wire Interface	2WI
RADIO G5	RG5
RADIO G5H	G5H
RADIO G5L	G5L
Radio G 4.5	R45
External Antenna Radio G 4.5	E45
Radio G 4	R40
Radio Analog Interface	RFA
Radio Interface w/out Master	RFI
EC/Ph Interface	EPI
Smart Pump	FSP
Platform	FPL
Weather Station	WEI
Z-Wire Analog Interface	2WA
Local Temperature & Humidity	LTH
Radio Temperature & Humidity	RTH
Radio Analog Interface	RFA
Z-Wire Analog Interface	2WA
Z-Wire Parts	ZWP

Additional Feature 4	Code
Z-Wire Interface	2WI
RADIO G5	RG5
RADIO G5H	G5H
RADIO G5L	G5L
Radio G 4.5	R45
External Antenna Radio G 4.5	E45
Radio G 4	R40
Radio Analog Interface	RFA
Radio Interface w/out Master	RFI
EC/Ph Interface	EPI
Smart Pump	FSP
Platform	FPL
Weather Station	WEI
Z-Wire Analog Interface	2WA
Local Temperature & Humidity	LTH
Radio Temperature & Humidity	RTH
Radio Analog Interface	RFA
Z-Wire Analog Interface	2WA
Z-Wire Parts	ZWP

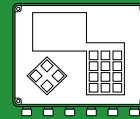

GreenApp 3-Way Controller, Application Operated

GreenApp 3-Way

Description	Catalog Number
GreenApp 3-Way Controller, Application Operated	BG5B0301D0000BAP-KIT



New

BIC 1 - One Station Irrigation Controller

BIC 1

Description	Catalog Number
BIC1 Controller KIT with 3/4" valve	B01007GPBPN121UC9DS*00IR-M1
BIC1 Controller KIT with 1" valve	B01010GPBPN121UC9DS*00IR-M1

* = Options for languages (English / Spanish)



BIC 2 / 4 / 6 - Two, Four or Six Stations Irrigation Controller

BIC 2 - 4 - 6

Description	Catalog Number
BIC2 Controller KIT (Box Controller and IOM)	B02B0302D00100*00000
BIC2 Controller KIT with 2x3/4" Valves and PRV	B02007GPBPN121UC9DS*00IR-M2
BIC2 Controller KIT with 2x1" Valves and PRV	B02010GPBPN121UC9DS*00IR-M2
BIC4 Controller KIT (Box Controller and IOM)	B04B0304D00100*00000
BIC4 Controller KIT with 3x3/4" Valves and PRV	B04007GPBPN121UC9DS*00IR-M3
BIC4 Controller KIT with 3x1" Valves and PRV	B04010GPBPN121UC9DS*00IR-M3
BIC6 Controller KIT (Box Controller and IOM)	B06B0306D00100*00000
BIC6 Controller KIT with 3x3/4" Valves and PRV	B06007GPBPN121UC9DS*00IR-M3
BIC6 Controller KIT with 3x1" Valves and PRV	B06010GPBPN121UC9DS*00IR-M3

* = Options for languages (English / Spanish)



BIC F Filter Flush Controllers

with Analog DP

BIC F

Description	Out/In	Power Supply / Output	Catalog Number
BIC F DC	2 / PD	6VDC / DC Latch	BFIB0602D002DPEN00
	4 / PD		BFIB0604D002DPEN00
	6 / PD		BFIB0606D002DPEN00
	8 / PD		BFIB0608D002DPEN00
	10 / PD		BFIB0610D002DPEN00
BIC F AC	2 / PD	220VAC / AC	BFI22002A002DPEN00
	4 / PD		BFI22004A002DPEN00
	6 / PD		BFI22006A002DPEN00
	8 / PD		BFI22008A002DPEN00
	10 / PD		BFI22010A002DPEN00
	2 / PD	110VAC / AC	BFI12002A002DPEN00
	4 / PD		BFI12004A002DPEN00
	6 / PD		BFI12006A002DPEN00
	8 / PD		BFI12008A002DPEN00
	10 / PD		BFI12010A002DPEN00



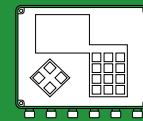

BIC 100 Agriculture Economical Irrigation Controller

BIC 100

Description	Out/In	Power Supply / Output	Catalog Number
BIC 100 DC	2 / 3	6VDC / DC Latch	B11B0602D00300EN00
	4 / 3		B11B0604D00300EN00
	6 / 3		B11B0606D00300EN00
	8 / 3		B11B0608D00300EN00
	10 / 3		B11B0610D00300EN00
	2 / 3	12VDC / DC Latch	B11B1202D00300EN00
	4 / 3		B11B1204D00300EN00
	6 / 3		B11B1206D00300EN00
	8 / 3		B11B1208D00300EN00
	10 / 3		B11B1210D00300EN00
BIC 100 AC	2 / 3	220VAC / AC	B1122002A00300EN00
	4 / 3		B1122004A00300EN00
	6 / 3		B1122006A00300EN00
	8 / 3		B1122008A00300EN00
	10 / 3		B1122010A00300EN00
	2 / 3	110VAC / AC	B1112002A00300EN00
	4 / 3		B1112004A00300EN00
	6 / 3		B1112006A00300EN00
	8 / 3		B1112008A00300EN00
	10 / 3		B1112010A00300EN00



BIC 1000 Time Based Professional Control- NO Communication

BIC 1000-NC

Description	Out/In	Power Supply / Output	Catalog Number
BIC 1000 AC	12/4	220VAC / AC	B1022012A00400**00
	18/4		B1022018A00400**00
	24/4		B1022024A00400**00
	30/4		B1022030A00400**00
	36/4		B1022036A00400**00
	12/4	110VAC / AC	B1012012A00400**00
	18/4		B1012018A00400**00
	24/4		B1012024A00400**00
	30/4		B1012030A00400**00
BIC 1000 DC Local outputs	16/4	DC / DC Latch	B10B1216D00400**00
	32/4		B10B1232D00400**00
BIC 1000 DC Local outputs and radio	16/4 + RF	DC / DC Latch local and radio	B10B1216D00400**00R45
	32/4 + RF		B10B1232D00400**00R45



**= Options for languages (EN=English / SP=Spanish / US=English US / PT=Portuguese)

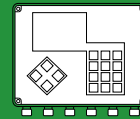

BIC 1000 Time Based Professional Control With Communication

BIC 1000-WC

Description	Out/In	Power Supply / Output	Catalog Number
BIC 1000 AC	12/4/2	220VAC / AC	B1022012A00402**TG000
	18/4/2		B1022018A00402**TG000
	24/4/2		B1022024A00402**TG000
	30/4/2		B1022030A00402**TG000
	36/4/2		B1022036A00402**TG000
	12/4/2	110VAC / AC	B1012012A00402**TG000
	18/4/2		B1012018A00402**TG000
	24/4/2		B1012024A00402**TG000
	30/4/2		B1012030A00402**TG000
	36/4/2		B1012036A00402**TG000



**= Options for languages (EN=English / SP=Spanish / US=English US / PT=Portuguese)

Communication for BIC 1000

Description	Catalog Number
BIC 1000 Spot Mobile Device Cloud Access Initial License	B10SPTINT00000AL00
BIC 1000 User Name Cloud Use Additional License	B10UNMADD00000AL00
BIC 1000 Target Cloud Use Additional License	B10TRCADD00000AL00
BIC 1000 Target Cloud Use Annual Charge	B10TRCANN00000AL00
BIC 1000 User Name Cloud Use Annual Charge	B10UNMANN00000AL00

BIC1500 DC

BIC 1500

Description	Out/Dig-In/Ana-In	Power Supply / Output	Catalog Number
BIC1500 DC + WiFi + Modem 3G	4/8/4	DC/DC Latch	B15B1204D00804ALTG
	8/8/4		B15B1208D00804ALTG
	12/8/4		B15B1212D00804ALTG
	16/8/4		B15B1216D00804ALTG
BIC1500 DC + WiFi + Modem 3G + RF G5	4/8/4	DC/DC Latch	B15B1204D00804ALTGRG5
	8/8/4		B15B1208D00804ALTGRG5
	12/8/4		B15B1212D00804ALTGRG5
	16/8/4		B15B1216D00804ALTGRG5



* Battery & Solar Panel are not include

BIC1500 Communication from PC Software CONSOLE

Description	Catalog Number
BIC1500 CONSOL PC SOFTWARE SINGLE USER LICENSE, Initial License	B15CONINT00000AL00
BIC1500 CONSOL PC SOFTWARE SINGLE USER LICENSE, Additional License	B15CONADD00000AL00
BIC1500 Target Cloud Use ADDITIONAL LICENSE	B15TRCADD00000AL00

BIC1500 Communication from mobile device SPOT

Description	Catalog Number
BIC1500 SPOT Mobile Device Cloud Access Initial License	B15SPTINT00000AL00
BIC1500 SPOT User Name Cloud Use ADDITIONAL LICENSE	B15SPTADD00000AL00
BIC1500 Target Cloud Use ADDITIONAL LICENSE	B15TRCADD00000AL00

* The customer will have to purchase a SIM card (standard size) with web browsing package (min – 50MB)

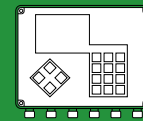

BIC1500 Cloud Use Annual Charge

Description	Catalog Number
BIC1500 Target Cloud Use Annual Charge	B15TRCANN00000AL00
BIC1500 User Name Cloud Use Annual Charge	B15UNMANN00000AL00

BIC 2500 Complete Management System

Local and Central Monitoring, Analyzing and Control Systems With Cellular Communication

BIC 2500

Description	Out/In	Power Supply / Output	Catalog Number
BIC 2500 Local outputs and inputs	16/8	220VAC / AC	B2522016A00800ALTG000
	32/16		B2522032A01600ALTG000
	16/8	110VAC / AC	B2512016A00800ALTG000
	32/16		B2512032A01600ALTG000
	16/8	220VAC / DC	B2522016D00800ALTG000
	32/16		B2522032D01600ALTG000
	16/8	110VAC / DC	B2512016D00800ALTG000
	32/16		B2512032D01600ALTG000
	16/8	DC / DC Latch	B25B1216D00800ALTG000
	32/16		B25B1232D01600ALTG000
BIC 2500 Local and radio outputs and inputs	16/8 + 1000 RF	220VAC / AC Local and DC Latch radio	B2522016A00800ALTGR45
	32/16 + 1000 RF		B2522032A01600ALTGR45
	16/8 + 1000 RF	110VAC / AC Local and DC Latch radio	B2512016A00800ALTGR45
	32/16 + 1000 RF		B2512032A01600ALTGR45
	16/8 + 1000 RF	220VAC / DC Local and DC Latch radio	B2522016D00800ALTGR45
	32/16 + 1000 RF		B2522032D01600ALTGR45
	16/8 + 1000 RF	110VAC / DC Local and DC Latch radio	B2512016D00800ALTGR45
	32/16 + 1000 RF		B2512032D01600ALTGR45
16/8 + 1000 RF	DC / DC Latch local and radio	B25B1216D01600ALTGR45	
32/16 + 1000 RF		B25B1232D01600ALTGR45	
BIC 2500 Radio outputs and inputs	1000 / 1000	220VAC / DC Latch radio	B2522000000000ALTGR45
		110VAC / DC Latch radio	B2511000000000ALTGR45
		DC / DC Latch radio	B25B1200000000ALTGR45
BIC 2500 Local and 2-wire outputs and inputs	16/8 + 1000 2W	220VAC / AC Local and DC Latch 2-Wire	B2522016A00800ALTG2WI
	32/16 + 1000 2W		B2522032A01600ALTG2WI
	16/8 + 1000 2W	110VAC / AC Local and DC Latch 2-Wire	B2512016A00800ALTG2WI
	32/16 + 1000 2W		B2512032A01600ALTG2WI
	16/8 + 1000 2W	220VAC / DC Local and DC Latch 2-Wire	B2522016D00800ALTG2WI
	32/16+ 1000 2W		B2522032D01600ALTG2WI
	16/8 + 1000 2W	110VAC / DC Local and DC Latch 2-Wire	B2512016D00800ALTG2WI
	32/16 + 1000 2W		B2512032D01600ALTG2WI
16/8 + 1000 2W	DC / DC Latch local and 2-wire	B25B1216D00800ALTG2WI	
32/16 + 1000 2W		B25B1232D01600ALTG2WI	
BIC 2500 2-Wire outputs and inputs	1000 / 1000	220VAC / DC Latch 2-wire	B2522000000000ALTG2WI
		110VAC / DC Latch 2-wire	B2511000000000ALTG2WI
		DC / DC Latch 2-wire	B25B1200000000ALTG2WI



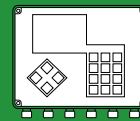

BIC 2500 Complete Management System

Local and Central Monitoring, Analyzing and Control System With Cellular Communication with Radio G5

BIC 2500-G5

New

Description	Out/In	Power Supply / Output	Catalog Number
BIC 2500 Local and G5 radio outputs and inputs	16/8 + 1000 RF	220VAC / AC Local and DC Latch radio	B2522016A00800ALTGG5L
	32/16 + 1000 RF	DC Latch radio	B2522032A01600ALTGG5L
	16/8 + 1000 RF	110VAC / AC Local and DC Latch radio	B2512016A00800ALTGG5L
	32/16 + 1000 RF	DC Latch radio	B2512032A01600ALTGG5L
	16/8 + 1000 RF	220VAC / DC Local and DC Latch radio	B2522016D00800ALTGG5L
	32/16 + 1000 RF	DC Latch radio	B2522032D01600ALTGG5L
	16/8 + 1000 RF	110VAC / DC Local and DC Latch radio	B2512016D00800ALTGG5L
	32/16 + 1000 RF	DC Latch radio	B2512032D01600ALTGG5L
BIC 2500 G5 Radio outputs and inputs	1000/1000	220VAC / DC Latch radio	B2522000000000ALTGG5L
		110VAC / DC Latch radio	B2511000000000ALTGG5L
		DC / DC Latch radio	B25B1200000000ALTGG5L



Communication for BIC 2500

Description	Catalog Number
BIC2500 Consol PC Software Single User License, Initial License	B25CONINT00000AL00
BIC 2500 Target Cloud Use Additional License	B25TRCADD00000AL00
BIC2500 Consol PC Software Single User License, Additional License	B25CONADD00000AL00
BIC 2500 Spot Mobile Device Cloud Access Initial License	B25SPTINT00000AL00
BIC 2500 Spot Mobile Device Cloud Access Additional License	B25SPTADD00000AL00
BIC 2500 Target Cloud Use Annual Charge	B25TRCANN00000AL00
BIC 2500 User Name Cloud Use Annual Charge	B25UNMANN00000AL00

BIC 2500 Interfaces, Inputs and Sensors Add-on

Description	Inputs	Type	Catalog Number	
Interface	2	Temperature & Humidity Sensor	BAXTHI0000000000000000	
	11	Weather Station Interface	BAXOWS0000000000000000	
	16/8	Remote DC Interface	B2522016D008000000IOE	
	32/16		B2522032D008000000IOE	
	16/8	Remote AC Interface	B2522016A008000000IOE	
	32/16		B2522032A016000000IOE	
			External Radio Interface + RF Master G4.5	BTRRME000000000000R45
			Radio Master and Internal Interface, Radio G5L	BAXRMI000000000000G5L
			External 2W Interface	S-TG-0044
		2 In	Analog Interface	S-TG-0016
	4 In	S-TG-0057		
Sensors	4-20mA	Leaf Temperature Sensor	S-TG-0136	
	0-5V	Pressure Transducer	S-TG-0064	
	11	Weather Station 11 Parameters	BAXOWD0000000000WEI	

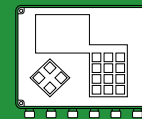

Solar Power and Batteries

Description	Power	Type	Catalog Number
Solar	RTU Kit	All	BAXK500000000000000000
	BIC 1000 Kit		BAXK200000000000000000
	5 Watt		BAXS500000000000000000
	10 Watt		BAXS100000000000000000
	20 Watt		BAXS200000000000000000
	1.3Ah Battery		BAX0B1000000000000000
	9Ah Battery		BAX0B9000000000000000
	2.5 Watt		S-TG-0021

G4.5 Radio Remote Terminal Units 6V

RTU G4.5-6V

Description	Out/In	Type	Catalog Number	
Radio 6V Battery operated	0/0	Modular	BRTB0600D000000000R45	
	2/0		BRTB0602D000000000R45	
	4/0		BRTB0604D000000000R45	
	6/0		BRTB0606D000000000R45	
	8/0		BRTB0608D000000000R45	
	0/4		BRTB0600D004000000R45	
	2/4		BRTB0602D004000000R45	
	4/4		BRTB0604D004000000R45	
	6/4		BRTB0606D004000000R45	
	8/4		BRTB0608D004000000R45	
	1/1		Economical Internal antenna	BRTB0601D000100000R45
	2/2		Economical Internal antenna	BRTB0602D000200000R45



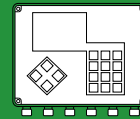

G4.5 Radio Remote Terminal Units 12V

RTU G4.5-12V

Description	Out/In	Type	Catalog Number
Radio RUT	0/0	* Modular	BRTB1200000000R45WOBAT
	2/0		BRTB1202D000000R45WOBAT
	4/0		BRTB1204D000000R45WOBAT
	6/0		BRTB1206D000000R45WOBAT
	8/0		BRTB1208D000000R45WOBAT
	0/4		BRTB12000004000R45WOBAT
	2/4		BRTB1202D004000R45WOBAT
	4/4		BRTB1204D004000R45WOBAT
	6/4		BRTB1206D004000R45WOBAT
	8/4		BRTB1208D004000R45WOBAT
	Radio RUT with 2 Analog inputs		0/0/2
2/0/2		BRTB1202D000020R45WOBAT	
4/0/2		BRTB1204D000020R45WOBAT	
6/0/2		BRTB1206D000020R45WOBAT	
8/0/2		BRTB1208D000020R45WOBAT	
0/4/2		BRTB12000004020R45WOBAT	
2/4/2		BRTB1202D004020R45WOBAT	
4/4/2		BRTB1204D004020R45WOBAT	
6/4/2		BRTB1206D004020R45WOBAT	
8/4/2		BRTB1208D004020R45WOBAT	
Radio RUT with 4 Analog inputs		0/0/4	* Modular
	2/0/4	BRTB1202D000040R45WOBAT	
	4/0/4	BRTB1204D000040R45WOBAT	
	6/0/4	BRTB1206D000040R45WOBAT	
	8/0/4	BRTB1208D000040R45WOBAT	
	0/4/4	BRTB12000004040R45WOBAT	
	2/4/4	BRTB1202D004040R45WOBAT	
	4/4/4	BRTB1204D004040R45WOBAT	
	6/4/4	BRTB1206D004040R45WOBAT	
	8/4/4	BRTB1208D004040R45WOBAT	
	Radio 12V Battery operated with Solar panel	1/1	
2/2		BRTB1202D000200000R45	



* RTU RF modular G4.5 powered by 5W Solar Panel (not include), with rechargeable battery 1.3 Ah (not include), with Battery charger limiter (not include)

Kit for Modular RF RTU G4.5

Description	Catalog Number
Power Kit for Modular RF RTU G4.5 includes 5W Solar Panel & 12V 1.3Ah Rechargeable Battery & Battery charger limite	BAXK50B11BCL000000000

ECO G5 Radio Remote Terminal Units

RTU G5-ECO

Description	Out/Dig-In/Ana-In	Type	Catalog Number
Economical RTU	1/1/2	* 12V Economical	BRTB1201D001020000G5L01M
	2/2/2		BRTB1202D002020000G5L01M
	1/1/2	6V Economical	BRTB0601D001020000G5L01M
	2/2/2		BRTB0602D002020000G5L01M

* RTU RF ECO G5 powered by Solar - 2.5W with rechargeable battery 1.3 Ah with Antenna 0.65m (Battery & Solar Panel not include)



New



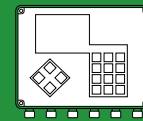

Modular G5 Radio Remote Terminal Units

RTU G5-MOD

Description	Out/Dig-In/Ana-In	Type	Catalog Number
Radio RTU 12V Battery operated with Solar Panel	2/0/0	* 12V Modular	BRTB1202D000000000G5L01M
	4/0/0		BRTB1204D000000000G5L01M
	6/0/0		BRTB1206D004000000G5L01M
	8/0/0		BRTB1208D000000000G5L01M
	2/4/0		BRTB1202D004000000G5L01M
	4/4/0		BRTB1204D004000000G5L01M
	8/4/0		BRTB1208D004000000G5L01M
	2/8/0		BRTB1202D008000000G5L01M
	4/8/0		BRTB1204D008000000G5L01M
	6/8/0		BRTB1206D008000000G5L01M
	8/8/0		BRTB1208D008000000G5L01M
	Radio RTU powered by 4 batteries Alkaline 1.5V size "D"		2/0/0
4/0/0		BRTB0604D000000000G5L01M	
6/0/0		BRTB0606D004000000G5L01M	
8/0/0		BRTB0608D000000000G5L01M	
2/4/0		BRTB0602D004000000G5L01M	
4/4/0		BRTB0604D004000000G5L01M	
8/4/0		BRTB0608D004000000G5L01M	
2/8/0		BRTB0602D008000000G5L01M	
4/8/0		BRTB0604D008000000G5L01M	
6/8/0		BRTB0606D008000000G5L01M	
8/8/0		BRTB0608D008000000G5L01M	



* RTU RF ECO G5 powered by Solar - 2.5W with rechargeable battery 3.3 Ah with Antenna 0.65m (Battery & Solar Panel not include)

2-Wire Remote Terminal Units

RTU 2-WIRE

Description	Out/In	Type	Catalog Number
Two-Wire	2/0	Modular	BRT2WM02D0000000002WP
	4/0		BRT2WM04D0000000002WP
	6/0		BRT2WM06D0000000002WP
	8/0		BRT2WM08D0000000002WP
	2/4		BRT2WM02D0040000002WP
	4/4		BRT2WM04D0040000002WP
	6/4		BRT2WM06D0040000002WP
	8/4		BRT2WM08D0040000002WP
	2/8		BRT2WM02D0080000002WP
	4/8		BRT2WM04D0080000002WP
	6/8		BRT2WM06D0080000002WP
	8/8		BRT2WM08D0080000002WP
	1/1	Economical	BRT2WE01D0010000002WP
	2/1		BRT2WE02D0010000002WP
	1/0+TH Sensors		BRT2WE01D000TH00002WP
	2/0+TH Sensors		BRT2WE02D000TH00002WP



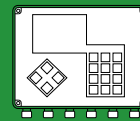

Uniliner BUS System

Uniliner

Description	Out/In	Type	Catalog Number
Radio 220V AC Power Supply	8/0	Modular	BUN22008A00000ENR45
	16/0		BUN22016A00000ENR45
	24/0		BUN22024A00000ENR45
	32/0		BUN22032A00000ENR45
	8/8		BUN22008A00800ENR45
	16/8		BUN22016A00800ENR45
	24/8		BUN22024A00800ENR45
	32/8		BUN22032A00800ENR45
	Two-Wire 220V AC Power Supply		8/0
16/0		BUN22016A00000EN2WI	
24/0		BUN22024A00000EN2WI	
32/0		BUN22032A00000EN2WI	
8/8		BUN22008A00800EN2WI	
16/8		BUN22016A00800EN2WI	
24/8		BUN22024A00800EN2WI	
32/8		BUN22032A00800EN2WI	



Fertilizers and Chemical Injection

Fert

Description	Power	Type	Catalog Number
Single Fert Injector	AC/DC	Smart Pump	S-TG-0227
EC and pH	AC	EC/pH Interface	BAX220000000000000EPI
		pH Sensor	BSNOPH000000000000EPI
		EC Sensor	BSNOEC000000000000EPI
		Calibration Solution for ph-4	S-TG-0187
		Calibration Solution for ph-7	S-TG-0188
		EC-2.63 Milisiemens	S-TG-0189
Auxiliary	AC	1" Fertilizer meter w/ Pulse	EXFERTSFNTPUS

Lightning Protection

Description	Out	Type	Catalog Number
Lightning Protection Units	16	AC	BAXLIG16A000000000000
	32		BAXLIG32A000000000000
	16 Card		S-TG-0217
	2		S-TG-0135

Pump Start and Dry Contact Relays

Description	Power	Type	Catalog Number
Electric Relay	24VAC	Solid State Ac Pump Start	S-TG-0026
			S-TG-0025
	12VDC Latch	Latch relay card	S-TG-0178
		Latch Relay 12V DC in Box	S-TG-0694



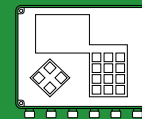

Spare Parts

Description	Card	Type	Catalog Number
BIC 1000	CPU	All	S-TG-0081
	Display		S-TG-0086
	kBD & LED		S-TG-0084
	Keyboard		S-TG-0083
	I/O Board		S-TG-0198
	Transformer		BAXTR1000000000000000
	Anti-Surge		S-TG-0007
	6 Out Card AC		B10E2806A00000000000
	16 Out Card DC		B100I016D000000000000
	BIC 2500		BIC2500 CPU card
Controller Display		B25LCD0000000000000000	
Keyboard		S-TG-0267	
Motherboard		EXSP/DRMB000	
Transformer 2x115V/ 24V/ 12V 90VA		S-TG-0168	
BIC2500 AC/AC, DC Power Supply Card		S-TG-0268	
16/8 DC I/O		B250I016D008000000000	
16/8 AC I/O		B250I016A008000000000	
2 Local Analog			
4 Local Analog			
AC/DC Interface			
RF Interface			
2W Interface			
Radio		2 Out	All
	4 Digital In	BRT0I0000004000000000	
	Eco RTU Base repair kit	BRTREK0000000000000000	
	Modular RTU Base repair kit	BRTRBK0000000000000000	
	Slave Card	BRTRSC0000000000000000	
	Slave repair kit 4.5G	BRTRSK000000000000R45	
	Antenna extention cable and bracket	S-TG-0261	
	Antenna		
	Master Card	BAXRMC0000000000000000	
	2 Analog		
	4 Analog		

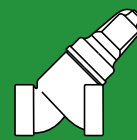

PRV Series

The BERMAD Adjustable Direct Acting Pressure Reducer is actuated by a pressure responsive diaphragm, which seeks to reach equilibrium between hydraulic and set spring force.

The BERMAD Model PRV is built of reinforced plastic that endows it with excellent hydraulic performance capabilities and high mechanical strength. It reduces higher upstream pressure to lower constant downstream pressure regardless of fluctuating demand or varying upstream pressure.

Features and Benefits

- Advanced Construction Materials
 - High mechanical strength
 - Proven pressure, flow and weather resistance
- Adjustable Direct Acting Pressure Reducer
 - Constant downstream pressure
 - Immediate response
 - Can be reset per season and stage
- Plastic Body and Trim
 - Highly durable, chemical and cavitation resistant
 - Minimizes friction
- Unitized Rolling Diaphragm and Guided Plug
 - Accurate and stable regulation
 - Prevents diaphragm distortion
- User-Friendly Design
 - Can be installed at any orientation
 - Simple in-line inspection and service

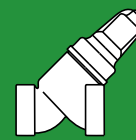

3/4" - PRV

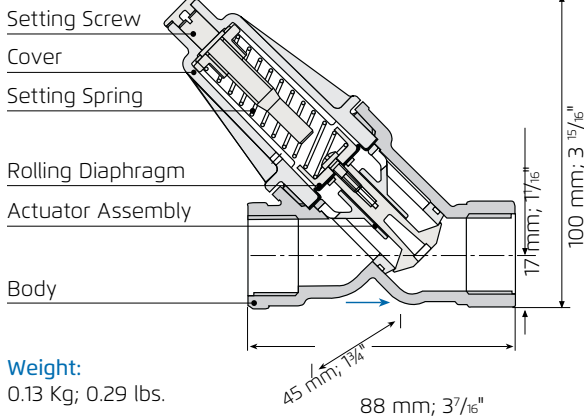

Technical Data

Size: 3/4"; DN20
End Connections: Threaded
Inlet: Female BSP; NPT
Outlet: Female BSP; NPT or Male BSPT; NPT
Flow Range: 0.2-5 m³/h; 0.9-22 gpm
Pressure Ratings: 10 bar; 150 psi
Operating Pressure Range: 0.7-9 bar; 10-130 psi
Temperature: Water up to 60°C; 140°F
Materials:
Body, Cover and Actuator Assembly:
 Glass fiber reinforced polyamide 6
Diaphragm: NBR (Buna-N), Reinforced Nylon Fabric
Spring: Stainless Steel

1" - PRV

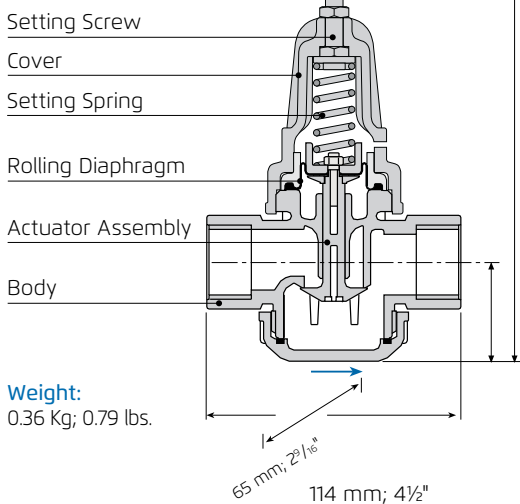

Technical Data

Size: 1"; DN25
End Connections: Female Threads BSP; NPT
Flow Range: 0.1-7 m³/h; 0.4-31 gpm
Pressure Ratings: 10 bar; 150 psi
Operating Pressure Range: 0.7-9 bar; 10-130 psi
Temperature: Water up to 60°C; 140°F
Materials:
Body, Cover and Actuator Assembly:
 Glass fiber reinforced polyamide 6
Diaphragm: NBR (Buna-N), Reinforced Nylon Fabric
Spring: Stainless Steel

1 1/2" - PRV

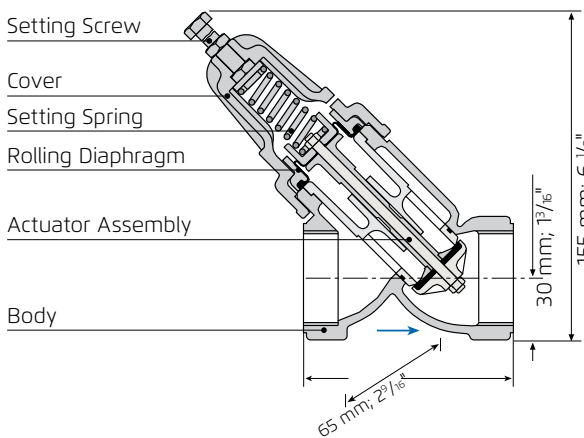

Technical Data

Size: 1 1/2"; DN40
End Connections: Female Threads BSP; NPT
Flow Range: 0.45-18 m³/h; 2-80 gpm
Pressure Ratings: 10 bar; 150 psi
Operating Pressure Range: 0.7-9 bar; 10-130 psi
Temperature: Water up to 60°C; 140°F
Materials:
Body: Glass fiber reinforced polyamide 6
Cover and Actuator Assembly:
 Glass fiber reinforced polyamide 6
Diaphragm: NBR (Buna-N), Reinforced Nylon Fabric
Spring: Stainless Steel

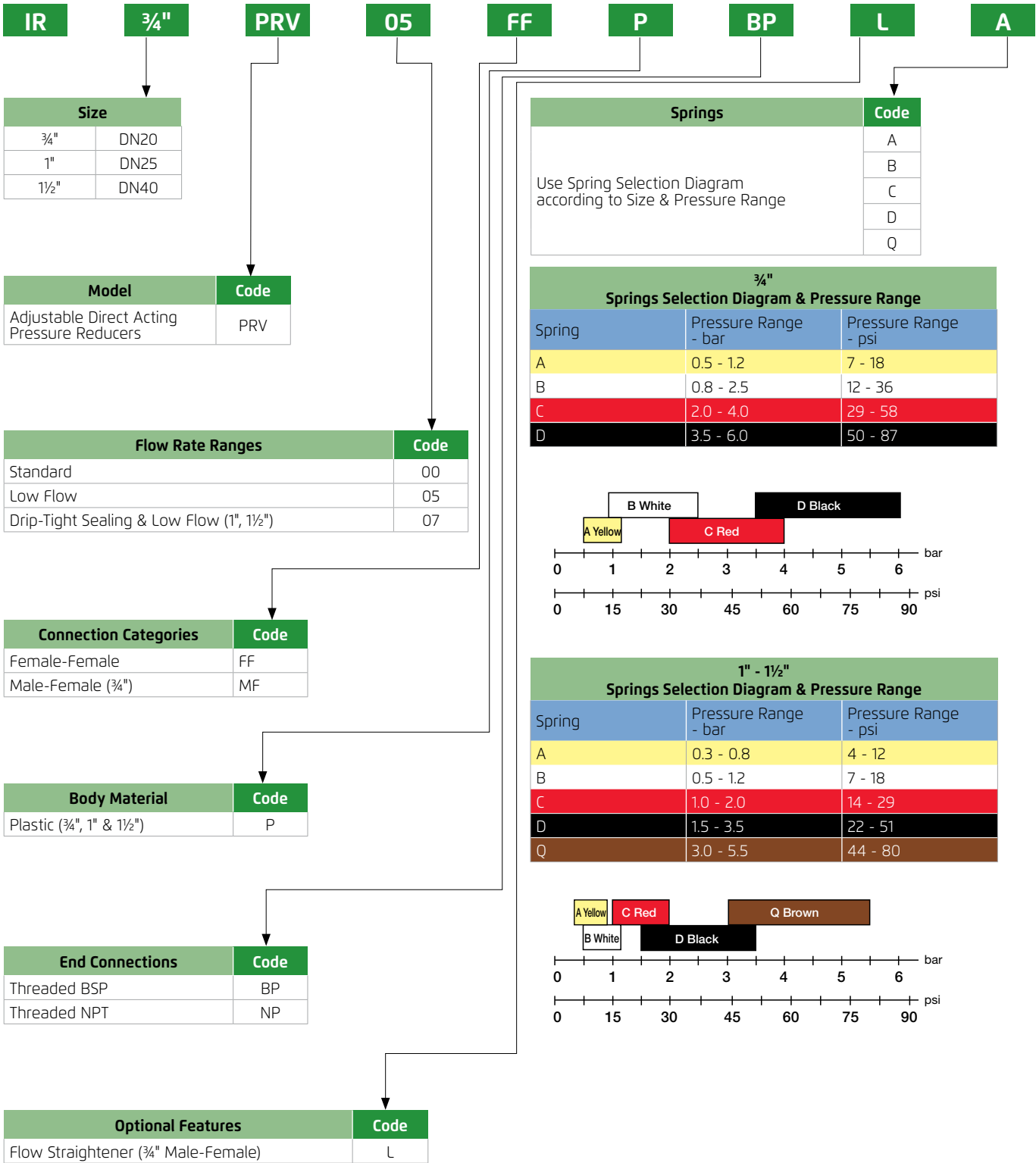
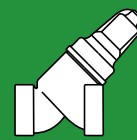



Adjustable Direct-Acting Pressure Reducer

Threaded Male - Female, Female - Female

3/4"-PRV

FLOW - 0.2-5.0 M³/h, 0.9-22.0 gpm

Spring	Color	Downstream Pressure Range- bar	Downstream Pressure Range - psi
A	Yellow	0.5 - 1.2	7 - 17
B	White	0.8 - 2.5	12 - 35
C	Red	2.0 - 4.0	30-60
D	Black	3.5 - 6.0	50 - 80



Adjustable Direct-Acting Low-Flow Pressure Reducer

Reducer Threaded Male - Female, Female - Female

3/4"-PRV-05

FLOW - 0.01 - 3.0 M³/h, 0.04 - 13.0 gpm

Spring	Color	Downstream Pressure Range- bar	Downstream Pressure Range - psi
A	Yellow	0.5 - 1.2	7 - 17
B	White	0.8 - 2.5	12 - 35
C	Red	2.0 - 4.0	30-60
D	Black	3.5 - 6.0	50 - 80



Adjustable Direct-Acting Pressure Reducer

Threaded Female - Female

1"-PRV

FLOW - 0.45 - 7.0 M³/h , 2.0 - 31.0 gpm

Spring	Color	Downstream Pressure Range- bar	Downstream Pressure Range - psi
B	White	0.5 - 1.2	7 - 17
C	Red	1.0 - 2.0	14 - 28
D	Black	1.5 - 3.5	22-50
Q	Brown	3.0 - 5.5	45 - 80



Adjustable Direct-Acting, Low Flow Pressure Reducer

Threaded Female - Female

1"-PRV-05

FLOW - 0.1 - 7.0 M³/h , 0.4 - 31.0 gpm

Spring	Color	Downstream Pressure Range- bar	Downstream Pressure Range - psi
B	White	0.5 - 1.2	7 - 17
C	Red	1.0 - 2.0	14 - 28
D	Black	1.5 - 3.5	22-50
Q	Brown	3.0 - 5.5	45 - 80





Adjustable Direct-Acting Pressure Reducer - PLASTIC

Plastic Threaded Female - Female

1½"-PRV-P

FLOW - 0.45 - 18.0 M³/h , 2.0 - 80.0 gpm

Spring	Color	Downstream Pressure Range- bar	Downstream Pressure Range - psi
B	White	0.5 - 1.2	7 - 17
C	Red	1.0 - 2.0	14 - 28
D	Black	1.5 - 3.5	22-50
Q	Brown	3.0 - 5.5	45 - 80



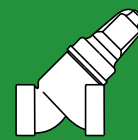

Packing Specifications

¾", 1"

1½" Plastic

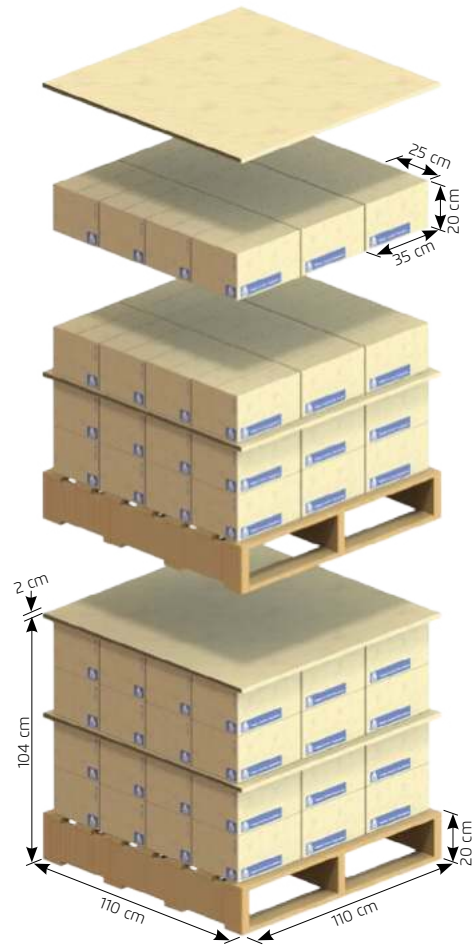
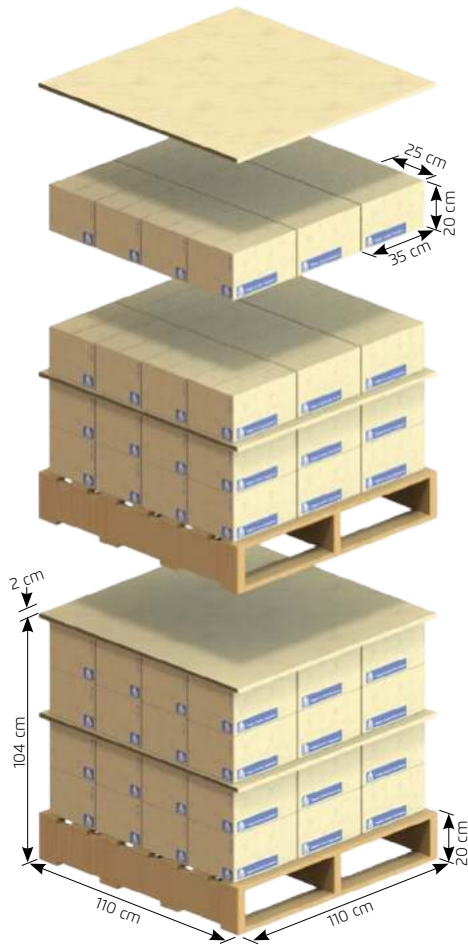

Per Box

Valve Size	Box					
	Units	Length [cm]	Width [cm]	Height [cm]	Weight [kg]	Volume [m ³]
¾"	50	35	25	20	6.6	0.02
1"	15	35	25	20	4.9	0.02
1½" Plastic	10	35	25	20	5.1	0.02

Per Pallet

Valve Size	Pallet							
	Number of Boxes	Number of Levels	Number of Units	Length [cm]	Width [cm]	Height [cm]	Gross Weight [kg]	Volume [m ³]
¾"	48	4	2400	110	110	104	336	1.3
1"	48	4	720	110	110	104	255	1.3
1½" Plastic	48	4	480	110	110	104	265	1.3



S-Series

Continuous Current Solenoids

BERMAD Continuous Current Solenoids are specially designed for reliable long life service in irrigation systems. They excel in their low power consumption and low sensitivity to dirt and voltage variations and are compliant with all Continuous Current Controllers on the market.

Latching Solenoids Series

BERMAD Latching Solenoids are specially designed for reliable long life service in irrigation systems controlled by Battery Operated Controllers. The Latching Solenoids consume power only when switching positions, using a very short electric impulse. This prolongs life of batteries and enables solar recharging.





2-Way Solenoid Actuator

S-390-2W / S-390T-2W

The BERMAD S-390-2W is a compact 2-Way, Normally Closed, Solenoid Actuator. It is applicable directly to the valve cover or with a 2-Way base that enables combining the S-390-2W in a variety of 2-Way control circuits.

Electrical Data

Actuator Type	Cable Color	Power (Watt)	Current (Amp)		Resistance ohm@20°C; 68°F
			Inrush	Hold	
S390T-2W-24VAC-R	Red/Red	1.7	0.25	0.125	37.5
S390T-2W-24VAC-D	Red/Orange	2.2	0.13	0.13	*
S390T-2W-24VDC	Black/Black	3.6	0.18	0.18	156
S390T-2W-12VDC	Blue/Blue	4.0	0.33	0.33	36

* Coil resistance in this coil can not be measured



3-Way Solenoid

S-390-3W-B

The BERMAD S-390-3W is a compact 3-Way Solenoid. It can control valves independently or in combination with other control circuit accessories. The hydraulic base features a manual override and consists of a bracket for attaching to the valve or to a solenoid manifold.

Electrical Data

Actuator Type	Cable Color	Power (Watt)	Current (Amp)		Resistance ohm@20°C; 68°F
			Inrush	Hold	
S-390-3W-24VDC NO & NC	Black/Black	4.2	0.17	0.17	135
S-390-3W-12VDC NO & NC	Blue/Blue	4.0	0.33	0.33	36
S-390-3W-24VAC-R NC	Red/Red	2.9	0.46	0.24	20
S-390-3W-24VAC-D NC	Red/Orange	3.5	0.2	0.2	*

* Coil resistance in this coil can not be measured

Actuator Port - Vent
1- Pressure
2- Valve Control Chamber



3-Way Solenoid with Trio Base

S-390T-3W

The BERMAD S-390-T-3W-BB is a compact 3-Way Solenoid Pilot Valve that can control valves independently or in combination with other control circuit accessories. The hydraulic base features a manual override and consists of a bracket for attaching to the valve or to a solenoid manifold.

Electrical Data

Actuator Type	Cable Color	Power (Watt)	Current (Amp)		Resistance ohm@20°C; 68°F
			Inrush	Hold	
S390T-24VDC-NO	Black/Black	4.2	0.17	0.17	135
S390T-12VDC-NO	Blue/Blue	4.0	0.33	0.33	36

Connections:
1- Vent
2- Valve Control Chamber
3- Actuator Port -Pressure



Magnetic Latch Solenoid Actuator, 2-Way, 9-20VDC Latch, 2- Leads

S-392T-2W

The BERMAD Model S-392-2W/S-392-T-2W is a compact 2-Way Latching Solenoid Actuator. It is applicable directly to the valve cover or with a 2-way base that enables combining it in variety of 2-way control circuits.

Electrical Data:

Voltage Range: 9-20 VDC

Coil Resistance: 6

Coil Inductance: 90 mH

Pulse Width: 20-100 mSec.

Operation Modes (electrical connections):

+Red & -Black: Latch Position

+Black & -Red: Released Position





Magnetic Latch Solenoid with Hydraulic Base

3-Way, 9-20VDC Latch, 2- Leads

S-392-T-3W-B

The BERMAD Model S-392T-3W can control valves independently or in combination with other control circuit accessories. The hydraulic base features a manual override and consists of a bracket for attaching to the valve or to a solenoid manifold.

Electrical Data:

- Voltage Range: 9-20 VDC
- Coil Resistance: 6
- Coil Inductance: 90 mH
- Pulse Width: 20-100 mSec
- Operation Modes (electrical connections):
- +Red & - Black: Solenoid vents
- +Black & - Red: Solenoid pressurizes

Pressure & Flow Data:

- Operating Pressure Range: 0-10 bar
- Top Orifice Diameter: 1.6 mm
- Base Flow Factor:
- Kv = 0.08 m³/h @ 1 bar ΔP; Cv= 0.09 GPM @1 psi ΔP

Connections:

- 1:..... Vent [N.O.], Pressure [N.C.]
- C:..... Valve control Chamber
- Actuator Port:... Pressure [N.O.], Vent [N.C.]



Dry Magnetic Latch Solenoid with Isolating Membrane & Hydraulic Base

3-Way, 12VDC Latch, 2/3- Leads

S-982/5-3W

The BERMAD Model S-982/5-3W actuator is neutralized from water damage by a membrane, which hermetically isolates it from the water. It can control valves independently or in combination with other control circuit accessories. The hydraulic base features a manual override and consists of a bracket for attaching to the valve or to a solenoid manifold.

Electrical Data:

- Voltage Range: 12-50 VDC
- Coil Resistance: 4.2
- Pulse Width: 20-100 mSec.
- Operation Modes (electrical connections):
- + Red & - Black: Solenoid vents
- + Black & - Red: Solenoid pressurizes

Pressure & Flow Data:

- Operating Pressure Range: 0-10 bar
- Base Orifice Diameter: 2 mm
- Base Flow Factor:
- Pressure port Kv = 0.12 m³/h @ 1 bar ΔP
Cv = 0.14 GPM @1 psi ΔP
- Exhaust port Kv = 0.14 m³/h @ 1 bar ΔP
Cv = 0.16 GPM @1 psi ΔP

Connections:

- 1- Vent 2- Valve Control Chamber 3- Pressure



Electrical Data for S-390-2W

Maximum cable length according to coil type

Cable cross section: 0.5 mm²,
orifice size: 1.8 mm, air gap: 0.7 mm

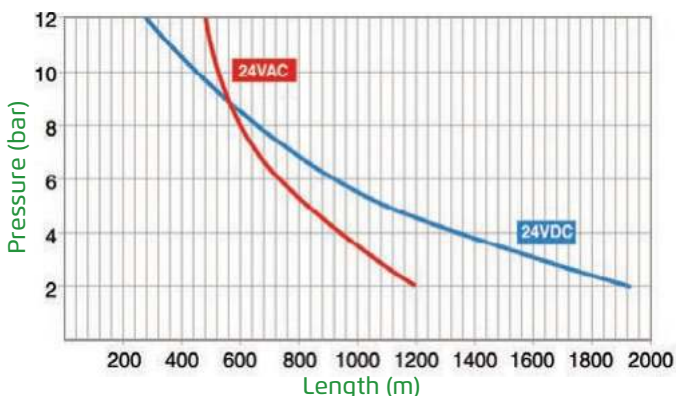

For cables longer than shown in diagram

In order to calculate the cross section of a length other than shown in the diagram, use the following equation:

$$S = \frac{L (sol)}{L (diagram)} \times 0.5$$

- S = Minimum conductor cross-section in mm²
- L (sol) = Actual Length of cable to solenoid
- L (diagram) = Length of cable shown in this diagram



Solenoid Selection Guide

The automation design is an integral part of the irrigation project design file. In order to help in the selection process of the most suitable solenoids for a given project, several questions need to be answered. Following the chart below, will guide you to the desired solenoid model. Please check selected solenoid specifications in the following pages, to confirm its suitability to the project conditions.

Please refer to the following questions for best navigation:

- **Operating Current:** Alternating Current (AC) or Direct Current (DC)
- **Solenoid Logic:** 2-Way or 3-Way
- **Actuator Type:** Continuous Current or Latching
- **Solenoid Normal Position:** Normally Open or Normally Closed
- **Controller Requirements:** Two Wires or Three Wires

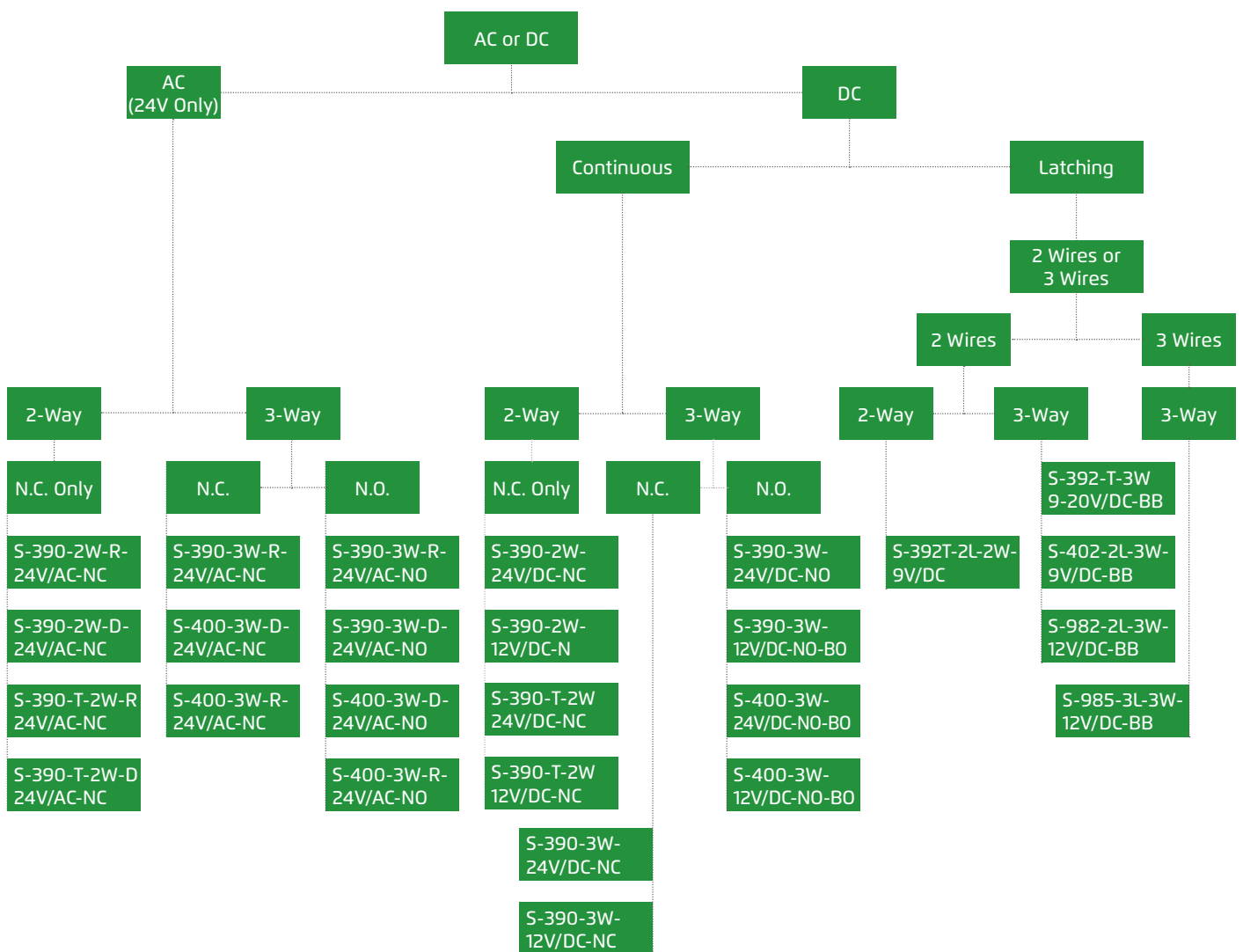

Notes:

- To get a 3-Way controlled N.C. main valve, use a N.O. 3-Way solenoid and vice versa.
- The S-982 and S-985 actuators are isolated from the water.
- Actuators with the suffix 'R' are suitable to areas with high lightning's probability
- Calculate wires cross section in accordance to:
 - System pressure conditions
 - Solenoids consumption, quantity & distance





2-Way Solenoid Actuator

S-390-2W - S-390-T-2W

Voltage	Normal State	Inrush (Amp)	Holding (Amp)	Power (Watt)
12VDC	N.C	0.33	0.330	4.00
24VDC	N.C	0.18	0.180	3.60
24VAC	N.C	0.25	0.125	1.70

S-390 / S-390-T-2W-R-24V/AC-NC



2-Way Solenoid Actuator with Plastic / Metal Base

S-390-T-2W-P - S-390-2W-M

Voltage	Normal State	Inrush (Amp)	Holding (Amp)	Power (Watt)
12VDC	N.C	0.33	0.330	4.00
24VDC	N.C	0.18	0.180	3.60
24VAC	N.C	0.25	0.125	1.70

S-390 / S-390-T-2W-R-24V/AC-NC



3-Way Solenoid Actuator

S-390-3W

Voltage	Normal State	Inrush (Amp)	Holding (Amp)	Power (Watt)
12VDC	N.O	0.33	0.330	4.00
24VDC	N.O	0.17	0.170	4.20
24VAC-D	N.O	0.13	0.130	2.20
24VAC-R	N.O	0.46	0.240	2.90
24VAC-D	N.C	0.20	0.200	3.50



3-Way Solenoid Actuator with Plastic / Metal Base

S-390-3W-P - S-390-3W-M

Voltage	Normal State	Inrush (Amp)	Holding (Amp)	Power (Watt)
12VDC	N.O	0.33	0.330	4.00
24VDC	N.O	0.17	0.170	4.20
24VAC-D	N.O	0.13	0.130	2.20
	N.C	0.20	0.200	3.50





Magnetic Latch Solenoid Actuator

S-392-T-2W

2-Way, 9-20V/DC Latch, 2-Leads

Voltage	Normal State	Min Pulse length (mSec)	Resistance (Ohm)
9-20	N.O / N.C	20	6

S-392-T-2L-2W-D-9-20V/DC



New

Magnetic Latch Solenoid

with Hydraulic Base

S-392-T-3W-P

3-Way, 9-20VDC Latch, 2- Leads

Voltage	Normal State	Min Pulse length (mSec)	Resistance (Ohm)
9-20	N.O / N.C	20	6



New

Dry Magnetic Latch Solenoid

with Isolating Membrane & Hydraulic Plastic / Metal Base

S-982-5-3W-P-M

3-Way, 12-50V/DC Latch, 2-Leads

Voltage	Normal State	Min Pulse length (mSec)	Resistance (Ohm)
12-50	N.O / N.C	20	4





Packing Specifications

S-390-2W

S-392-2W



S-390-3W



	S-390/392-2W	S-390-3W
No. of Layers	2	2
No. of Units	100	100
Length [cm]	35	35
Width [cm]	25	25
Height [cm]	20	20
Gross Weight	12.74	13.74
Volume [m ³]	0.02	0.02

S-390-3W-BB

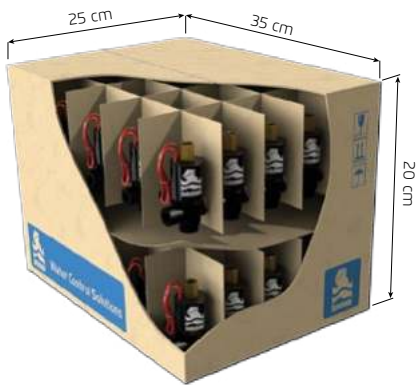

	S-390-3W-BB	
No. of Layers	2	1
No. of Units	50	25
Length [cm]	35	35
Width [cm]	25	25
Height [cm]	20	11.6
Gross Weight	8	4
Volume [m ³]	0.02	0.01

S-400/402; S-982/985



S-400/402; S-982/985	
No. of Layers	2
No. of Units	50
Length [cm]	31
Width [cm]	23
Height [cm]	24.5
Gross Weight	8.45
Volume [m ³]	0.02

S-400/402; S-982/985	
No. of Layers	1
No. of Units	6
Length [cm]	17.5
Width [cm]	10
Height [cm]	12.5
Gross Weight	1.3
Volume [m ³]	0.002

S-400/402; S-982/985	
No. of Layers	1
No. of Units	20
Length [cm]	25
Width [cm]	25
Height [cm]	15
Gross Weight	3
Volume [m ³]	0.01



Mini Pilots - Metal







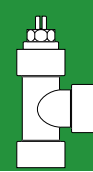

	Code	Description
	PC-SHARP-X-MP	3-Way Multi-Propose Mini Pilot Valve
	PC-20-A-MP	2-Way Pressure Reducing Mini Pilot Valve - Metal-Plastic Cover
	PC-2D-A-MP	2-Way Differential Pressure Reducing Mini Pilot Valve - Metal-Plastic Cover
	PC-S-A-MP	2/3-Way Mini Pilot Valve "Servo" Metal-Plastic Cover
	PC-SD-A-MP	2/3-Way Differential Pressure Sensing/Flow Pilot Valve "Servo" Metal-Plastic Cover
	PC-30-A-MP	2-Way Pressure Sustaining Mini Pilot Valve Metal-Plastic Cover
	PC-3D-A-MP	2-Way Differential Sustaining Mini Pilot Valve Metal-Plastic Cover
	PC-3Q-A-MP	2-Way Pressure Relief Mini (Quick Type) Pilot Valve Metal-Plastic Cover
	PC-70-M	2-Way Flow Pilot Valve (Paddle Type) - Metal

Mini Pilots - Plastic

	Code	Description
	PC-SHARP-X-P	3-Way Sharp Multi-Propose Mini Pilot - Plastic
	PC-SHARP-XD-P	3-Way Differential Mini Pilot Valve - Plastic
	PC-20-A-P	2-Way Pressure Reducing Mini Pilot Valve - Plastic
	PC-2D-A-P	2-Way Differential Pressure Reducing Mini Pilot Valve - Plastic
	PC-S-A-P	2/3-Way Mini Pilot Valve "Servo" - Plastic
	PC-SD-A-P	2/3-Way Differential Pressure Sensing/Flow Pilot Valve "Servo" - Plastic
	PC-30-A-P	2-Way Pressure Sustaining Mini Pilot Valve - Plastic
	PC-3Q-A-P	2-Way Pressure Relief Mini (Quick Type) Pilot Valve - Plastic
	PC-70-P	2-Way Flow Pilot Valve (Paddle Type) - Plastic



Pilots & Floats







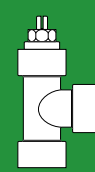







	Code	Description
	#2PBL	2-Way Pressure Reducing Pilot - Bronze 2" - 12"
	#3PBL	2-Way Pressure Sustaining Pilot - Bronze 2" - 12"
	#X	3-Way Multi Purpose Pilot - Brass
	#8	Altitude Positioning Pilot Valve
	#66	4-Way Bi-Level Vertical Pilot & Float Assembly
	#67	2-Way Modulating Vertical Float (Closed) Assembly
	#60P	Modulating Horizontal Float Assembly - Plastic
	#60M	Modulating Horizontal Float Assembly - Metal
	#65	Electric Float Switch Bi-Level

Relays

	Code	Description
	50-M	3/8" 2-Way Hydraulic Relay (2W-HRV) - Brass
	50-P	1/8" 2-Way Hydraulic Relay - Plastic (2W-HRV)
	54-XM	3/8" 3-Way Hydraulic Relay (3W-HRV) - Brass
	54-P	1/8" 3-Way Hydraulic Relay (3W-HRV) - Plastic



Accessories

	Code	Description			
	Z - SY3	1/8" 3-Way Selector		Y	3/8" OR Y-Strainer NPT Brass 500 Micron
	Z - SY6	1/4" 3-Way Selector		F	Large Control Filter
	50-XM	1/8" Metal Pressure Selecting Hydraulic Control (Shuttle Valve)		5	Plastic Gauges-Test Point
	50-XP	8x8mm Plastic Shuttle Valve Assy -T		6	Pressure Gauge up to 16 bar
	20-P	8x8mm Plastic Check Valve Assy (Blue & Grey)			
	20-M	3/8" Metal Check Valve			
	1	8x8mm Plastic One-Way Flow Restriction Assy (Blue, Grey & Red)			
	2	8 x 1/8" x 8 "T" Plastic Assy with Restriction Orifice (Grey & Red)			
	3	1/4" Brass Angle Needle Valve, Female-Female			
	C	1/4" In Line Filter Plastic Body			
	C1	1/4" In Line Filter, S.S. 316 Body			



Control Tube Fittings

	Code	Description
	FT 88	Tube Straight Connector 8mm - 8mm
	FT 18	Straight Connector 1/8"-8mm
	FT 78	Straight Connector 1/4"-8mm
	FT 28	Elbow Connector 1/8"-8mm
	FT 58	Elbow Connector 1/4"-8mm
	FT 38	1/8" NPT Male Plug
	FT 34	1/4" NPT Male Plug
	FT 32	3/8" NPT Male Plug
	FT 30	1/2" BSPT Male Plug
	FT 11	Bushing Male-Female 1/8" - 1/8"
	FT 48	Bushing Male-Female 1/4" - 1/8"

	FT 98	T-Connector for Tube 8mm-8mm-8mm
	FT 98/1	T-Connector for Tube 8mm-1/8"-8mm
	FT 98/2	T-Connector for Tube 8mm-8mm - 1/8"
	FT 08	Coupler for 8mm Tube

BERMAD Standard International Limited Warranty

BERMAD CS LTD. ("BERMAD") warrants that, for a period of 12 months from the day of delivery of the product by BERMAD to its customer (the "Warranty Period"), each component of the product shall be free from defects in material or workmanship and shall meet, in all material respects, the products technical specifications as defined by BERMAD.

General Conditions

This warranty shall be valid only if the product is installed, handled and maintained in accordance with BERMAD's written or verbal instructions and/or recommendations, if such has been provided.

This Warranty does not cover defects or damages resulting from accident, inappropriate physical or operational environment, failure of electrical power, improper installation, maintenance, service, repair, transportation, storage, modification, operation, use, negligence or fault by any party other than BERMAD.

This Warranty shall run solely to and in favor of the customer that purchased the defective product directly from BERMAD, and it does not extend to any other purchaser or user of the product.

Claims, Notifications and Compensation

Every warranty claim must be notified in writing to BERMAD as soon as reasonably possible after the discovery of the defective product, enclosing the original sales receipt and this warranty.

The claimant must allow BERMAD to inspect the product involved and the installation site itself, while the product is still in its original position and has not been removed or altered in any way, and/or return the product to BERMAD for testing. BERMAD reserves the right to investigate independently the cause of any failure.

If a claim under this Warranty is properly notified within the Warranty Period and found to be justified by BERMAD, then BERMAD, at its sole option, shall: (i) replace such product; or (ii) repair such product; or (iii) repay to the BERMAD customer any amounts actually paid to BERMAD for such product.

In any way, BERMAD's liability shall not exceed the amounts actually paid by the BERMAD customer to BERMAD for the defective products.

Limitations

This Warranty is the sole warranty in respect to the products.

Under no circumstances shall BERMAD be liable for any indirect, special or consequential damages, and including, without limitation, for any loss of profit, loss in connection with business interruption, loss of use, loss of revenues or damage to business or reputation.

This warranty does not cover any costs and expenses of removal and installation of the product or shipping cost or taxes or any other direct or indirect loss(es) which may result from the product failure, and BERMAD shall not be liable for such costs and expenses.

OTHER THAN HAS BEEN SPECIFICALLY STATED IN THIS WARRANTY, ALL OTHER WARRANTIES, WHETHER EXPRESSED OR IMPLIED, INCLUDING ALL IMPLIED WARRANTIES OF FITNESS FOR A PARTICULAR PURPOSE ARE EXCLUDED SO FAR AS THE LAW PERMITS.



[ozbranding.co.il]



Irrigation

